

User's Manual

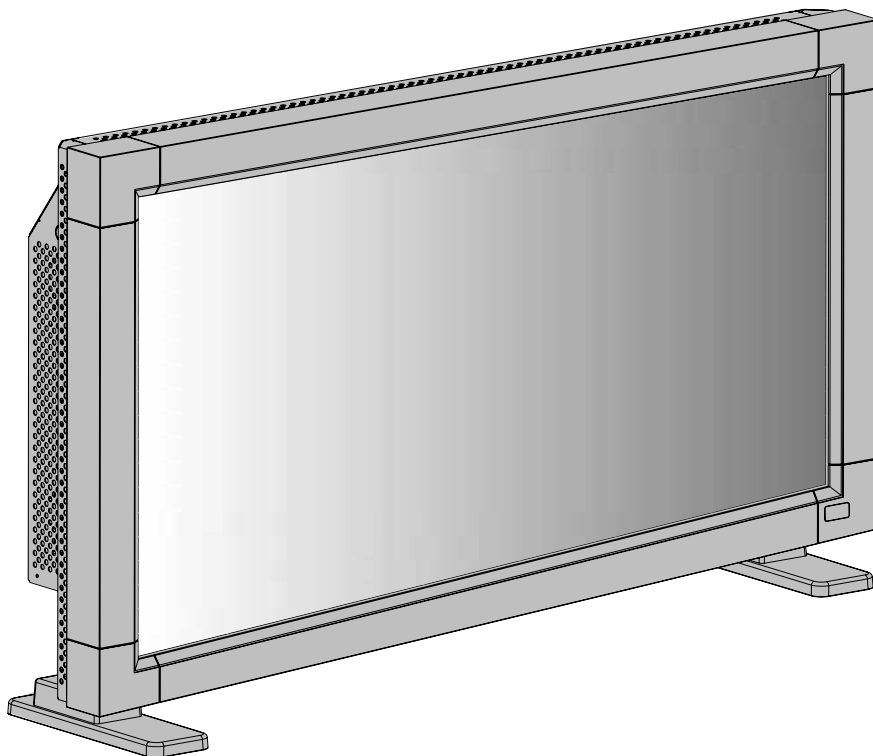

32" LCD Display Monitor **MDT321S**

**USER'S MANUAL
MANUEL UTILISATEUR
MANUAL DEL USUARIO**



Index

Important Information	English-1
Safety Precautions, Maintenance & Recommended Use	English-3
Contents	English-4
Parts Name and Functions	English-5
Control Panel	English-5
Terminal Panel	English-6
Wireless Remote Control	English-7
Operating Range for the Remote Control	English-8
Handling the remote control	English-8
Setup Procedure	English-9
How to Mount and Attach Options to the LCD Monitor	English-11
Connections	English-12
Wiring Diagram	English-12
Connecting a Personal Computer	English-13
Connect the LCD Monitor to a Personal Computer	English-13
Connecting with Digital Interface Equipment	English-14
Connect the LCD Monitor to a Computer with a Digital Output	English-14
Connecting a DVD Player with component out	English-15
Connect the LCD Monitor to a DVD Player	English-15
Connecting to a Stereo Amplifier	English-16
Connect the LCD Monitor to a Stereo Amplifier	English-16
Basic Operation	English-17
Power ON and OFF Modes	English-17
Power Indicator	English-18
Using Power Management	English-18
Selecting a video source	English-18
Picture Size	English-18
Picture Mode	English-18
Information OSD	English-18
OSD (On-Screen-Display) Controls	English-19
PICTURE	English-19
SCREEN	English-20
AUDIO	English-21
PICTURE IN PICTURE	English-22
CONFIGURATION 1	English-22
CONFIGURATION 2	English-23
ADVANCED OPTION	English-25
Controlling the LCD monitor via RS-232C Remote Control	English-28
Features	English-30
Troubleshooting	English-31
Specifications	English-32
Pin Assignment	English-33

Important Information

DECLARATION OF CONFORMITY

This device complies with Part 15 of FCC Rules. Operation is subject to the following two conditions. (1) This device may not cause harmful interference, and (2) this device must accept any interference received, including interference that may cause undesired operation.

U.S. Responsible Party:	Mitsubishi Digital Electronics America, Inc.
Address:	9351 Jeronimo Road, Irvine, California 92618 U.S.A.
Tel. No.:	+1 - (949) 465-6000

Type of Product:	Computer Monitor
Equipment Classification:	Class B Peripheral
Model:	MDT321S (L325RM)



We hereby declare that the equipment specified above conforms to the technical standards as specified in the FCC Rules.

Windows is a registered trademark of Microsoft Corporation. All other brands and product names are trademarks or registered trademarks of their respective owners.

Canadian Department of Communications Compliance Statement

DOC: This Class B digital apparatus meets all requirements of the Canadian Interference-Causing Equipment Regulations.

C-UL: Bears the C-UL Mark and is in compliance with Canadian Safety Regulations according to CAN/CSA C22.2 No. 60950-1.

FCC Information

- Use the attached specified cables with the MDT321S (L325RM) color monitor so as not to interfere with radio and television reception.
 - Please use the supplied power cord or equivalent to ensure FCC compliance.
 - Please use the supplied shielded video signal cable, 15-pin mini D-SUB to 15-pin mini D-SUB.
 - Please attach the ferrite cores on the Audio Cable. Please see page 12 of this manual.
- This equipment has been tested and found to comply with the limits for a Class B digital device, pursuant to part 15 of the FCC Rules. These limits are designed to provide reasonable protection against harmful interference in a residential installation. This equipment generates, uses, and can radiate radio frequency energy, and, if not installed and used in accordance with the instructions, may cause harmful interference to radio communications. However, there is no guarantee that interference will not occur in a particular installation. If this equipment does cause harmful interference to radio or television reception, which can be determined by turning the equipment off and on, the user is encouraged to try to correct the interference by one or more of the following measures:
 - Reorient or relocate the receiving antenna.
 - Increase the separation between the equipment and receiver.
 - Connect the equipment into an outlet on a circuit different from that to which the receiver is connected.
 - Consult your dealer or an experienced radio/TV technician for help.

If necessary, the user should contact the dealer or an experienced radio/television technician for additional suggestions. The user may find the following booklet, prepared by the Federal Communications Commission, helpful: "How to Identify and Resolve Radio-TV Interference Problems." This booklet is available from the U.S. Government Printing Office, Washington, D.C., 20402, Stock No. 004-000-00345-4.

Important Information



WARNING



TO PREVENT FIRE OR SHOCK HAZARDS, DO NOT EXPOSE THIS UNIT TO RAIN OR MOISTURE. ALSO, DO NOT USE THIS UNIT'S POLARIZED PLUG WITH AN EXTENSION CORD RECEPTACLE OR OTHER OUTLETS UNLESS THE PRONGS CAN BE FULLY INSERTED.

REFRAIN FROM OPENING THE CABINET AS THERE ARE HIGH VOLTAGE COMPONENTS INSIDE. REFER SERVICING TO QUALIFIED SERVICE PERSONNEL.



CAUTION



CAUTION: TO REDUCE THE RISK OF ELECTRIC SHOCK, MAKE SURE POWER CORD IS UNPLUGGED FROM WALL SOCKET. TO FULLY DISENGAGE THE POWER TO THE UNIT, PLEASE DISCONNECT THE POWER CORD FROM THE AC OUTLET. DO NOT REMOVE COVER (OR BACK). NO USER SERVICEABLE PARTS INSIDE. REFER SERVICING TO QUALIFIED SERVICE PERSONNEL.



This symbol warns user that uninsulated voltage within the unit may have sufficient magnitude to cause electric shock. Therefore, it is dangerous to make any kind of contact with any part inside this unit.



This symbol alerts the user that important literature concerning the operation and maintenance of this unit has been included. Therefore, it should be read carefully in order to avoid any problems.

CAUTION



This LCD Monitor uses a lamp that contains mercury. Disposal of the lamp or the LCD Monitor with the lamp may be regulated due to environmental considerations. For disposal or recycling information, please contact your local authorities or the Electronic Industries Alliance: www.eiae.org. (For US only).

Declaration

Declaration of the Manufacturer

We hereby certify that the color monitor MDT321S and marked with (L325RM) is in compliance with

Council Directive 73/23/EEC:
– EN 60950-1

Council Directive 89/336/EEC:
– EN 55022
– EN 61000-3-2
– EN 61000-3-3
– EN 55024



Mitsubishi Electric Corporation
2-2-3, Marunouchi,
Chiyoda-Ku
Tokyo 104-8310, Japan

Declaration of the Manufacturer



Your MITSUBISHI ELECTRIC product is designed and manufactured with high quality materials and components which can be recycled and reused.

This symbol means that electrical and electronic equipment, at their end-of-life, should be disposed of separately from your household waste.

Please, dispose of this equipment at your local community waste collection/recycling center.

In the European Union there are separate collection systems for used electrical and electronic product.

Please, help us to conserve the environment we live in!

Safety Precautions, Maintenance & Recommended Use

FOR OPTIMUM PERFORMANCE, PLEASE NOTE THE FOLLOWING WHEN SETTING UP AND USING THE MDT321S LCD COLOR MONITOR:

- **DO NOT OPEN THE MONITOR.** There are no user serviceable parts inside and opening or removing covers may expose you to dangerous shock hazards or other risks. Refer all servicing to qualified service personnel.
- Do not spill any liquids into the cabinet or use your monitor near water.
- Do not insert objects of any kind into the cabinet slots, as they may touch dangerous voltage points, which can be harmful or fatal or may cause electric shock, fire or equipment failure.
- Do not place any heavy objects on the power cord. Damage to the cord may cause shock or fire.
- Do not place this product on a sloping or unstable cart, stand or table, as the monitor may fall, causing serious damage to the monitor.
- When operating the MDT321S LCD monitor with its AC 220-240V power supply in Europe, use a power supply cord provided with the monitor.
- In UK, use a BS-approved power cord with molded plug having a black (13A) fuse installed for use with this monitor. If a power cord is not supplied with this monitor, please contact your supplier.
- When operating the MDT321S with a 220-240V AC power source in Australia, use the power cord provided with the monitor. If a power cord is not supplied with this equipment, please contact your supplier.
- For all other cases, use a power cord that matches the AC voltage of the power outlet and has been approved by and complies with the safety standard of your particular country.
- Do not place any objects onto the monitor and do not use the monitor outdoors.
- The inside of the fluorescent tube located within the LCD monitor contains mercury. Please follow the bylaws or rules of your municipality to dispose of the tube properly.
- Do not bend power cord.
- Do not use monitor in very hot, humid, dusty, or oily areas.
- If monitor or glass is broken, do not come in contact with the liquid crystal and handle with care.
- Allow adequate ventilation around the monitor, so that heat can properly dissipate. Do not block ventilated openings or place the monitor near a radiator or other heat sources. Do not put anything on top of the monitor.
- The power cable connector is the primary means of detaching the system from the power supply. The monitor should be installed close to a power outlet, which is easily accessible.
- Handle with care when transporting. Save packaging for transporting.
- Please clean the holes of back cabinet to reject dirt and dust at least once a year because of set reliability.
- If using the cooling fan continuously, it's recommended to wipe holes a minimum of once a month.

Immediately unplug your monitor from the wall outlet and refer servicing to qualified service personnel under the following conditions:

- When the power supply cord or plug is damaged.
- If liquid has been spilled, or objects have fallen into the monitor.
- If the monitor has been exposed to rain or water.
- If the monitor has been dropped or the cabinet damaged.
- If the monitor does not operate normally by following operating instructions.

Recommended Use

- For optimum performance, allow 20 minutes for warm-up.
- Rest your eyes periodically by focusing on an object at least 5 feet away. Blink often.
- Position the monitor at a 90° angle to windows and other light sources to minimize glare and reflections.
- Clean the LCD monitor surface with a lint-free, non-abrasive cloth. Avoid using any cleaning solution or glass cleaner!
- Adjust the monitor's brightness, contrast and sharpness controls to enhance readability.
- Avoid displaying fixed patterns on the monitor for long periods of time to avoid image persistence (after image effects).
- Get regular eye checkups.

Ergonomics

To realize the maximum ergonomic benefits, we recommend the following:

- Use the preset Size and Position controls with standard signals.
- Use the preset Color Setting.
- Use non-interlaced signals.
- Do not use primary color blue on a dark background, as it is difficult to see and may produce eye fatigue due to insufficient contrast.

Contents

Your new MDT321S monitor box* should contain the following:

- LCD monitor
- Power Cord (3m) for North America
- Power Cord (3m) for EU
- Video Signal Cable (4m)
- User's Manual
- Wireless Remote Control and AA Batteries
- Clamper x 3
- Screw (M4 x 8) x 4
- CD-ROM
- Band x 2
- Ferrite Core x 2
- Speaker Plug x 1set (Required for optional Loudspeakers)
- Stand for the Independence x 2
- Thumbscrew for stand (M4 x 27) x 2
- Thumbscrew for stand (M4 x 27) x 2
- Main switch cover

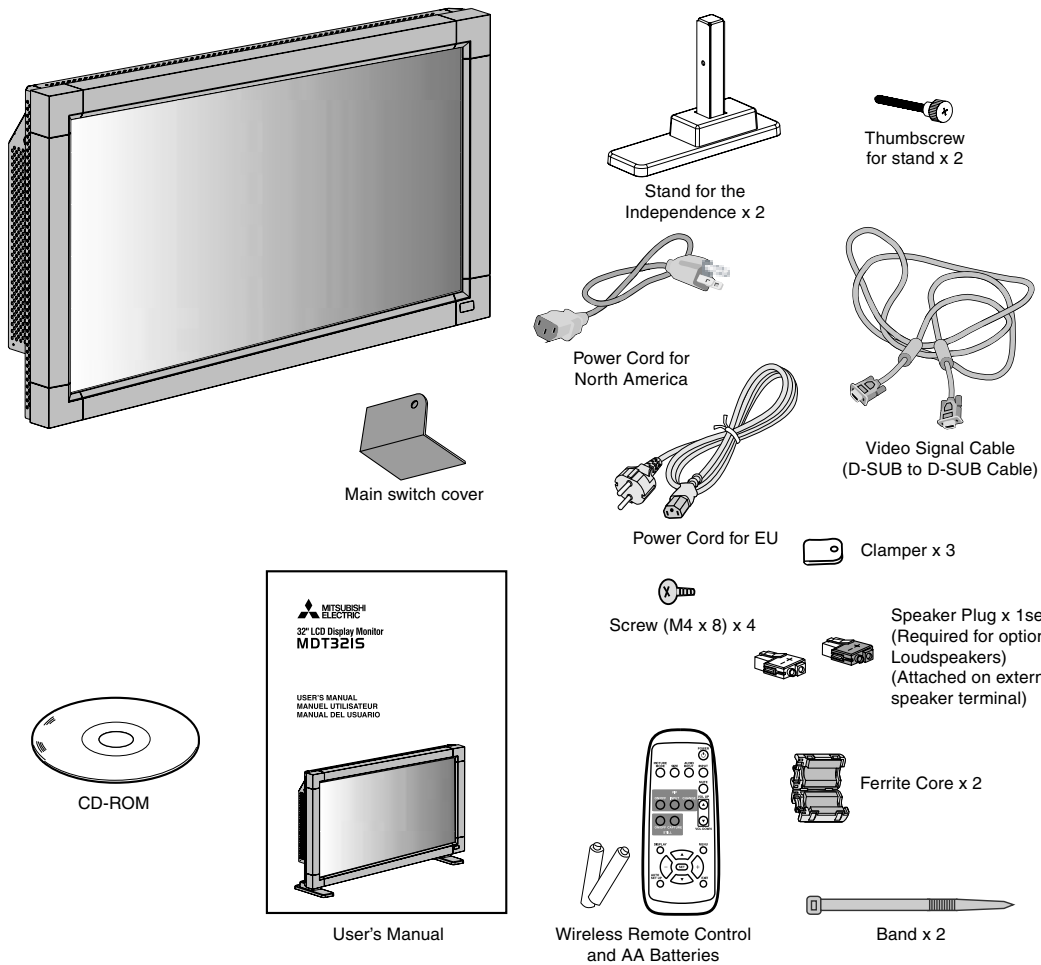

- * Install the stands at the time of unpacking if the display will be used with the stand.
- * Remember to save your original box and packing material to transport or ship the monitor.

The following components are prepared as option.

- External Speaker Unit

Parts Name and Functions

Control Panel

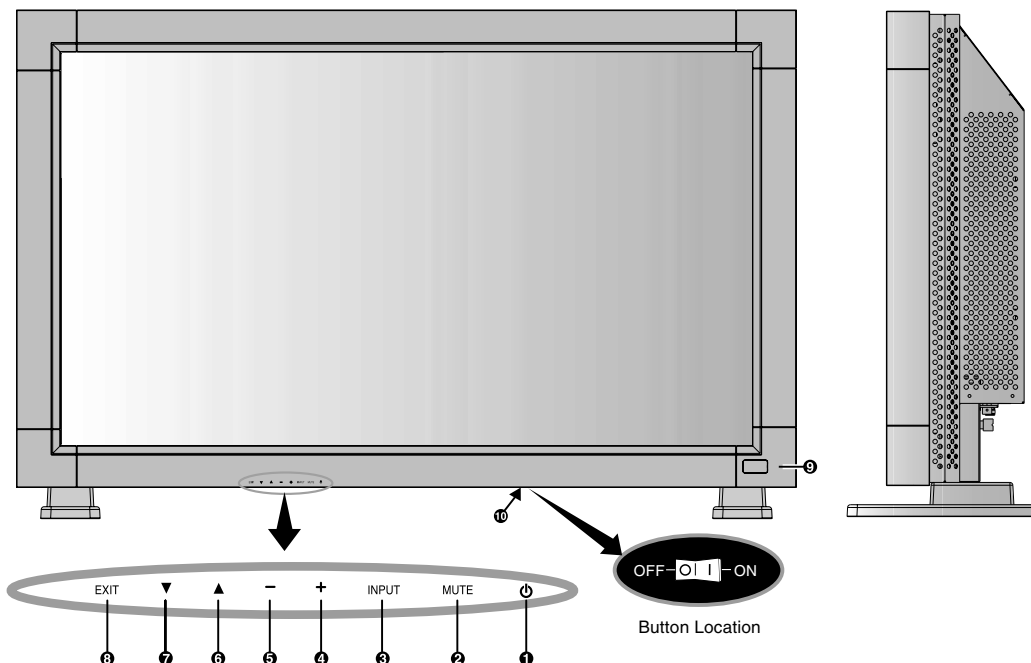

❶ POWER button (⏻)

Switches the power on/off. See also page 17.

❷ MUTE button

Switches the audio mute ON/OFF.

❸ INPUT button

Acts as SET button within OSD menu. (Toggle switches between [RGB1], [RGB2], [RGB3], [DVD/HD], [VIDEO] or [VIDEO<S>]). [VIDEO<S>] is enabled by selecting the "SEPARATE" mode in the OSD or by having the "S-VIDEO" cable connected with the "S-VIDEO" signal present and selecting "PRIORITY" MODE. See page 25.

❹ PLUS (+) button

Acts as (+) button to increase the adjustment with OSD menu. Increases the audio output level when the OSD menu is turned off.

❺ MINUS (-) button

Acts as (-) button to decrease the adjustment with OSD menu. Decreases the audio output level when the OSD menu is turned off.

❻ UP (▲) button

Activates the OSD menu when the OSD menu is turned-off. Acts as ▲ button to move the highlighted area up to select the adjustment with OSD menu.

❼ DOWN (▼) button

Activates the OSD menu when the OSD menu is turned-off. Acts as ▼ button to move the highlighted area down to select the adjustment with OSD menu.

❽ EXIT button

Activates the OSD menu when the OSD menu is turned-off. Acts as EXIT button to move to previous menu with OSD menu.

❾ Remote control sensor and Power Indicator

Receives the signal from the remote control (when using the wireless remote control). See also page 8.

Glows green when the LCD monitor is in active and glows red when the LCD monitor is in POWER OFF mode. When the LCD monitor is in POWER SAVE mode, it will glow both green and red. When SCHEDULE is enabled, it will blink green and glow red. See page 18.

In the case of where a failure is detected, it will blink red.

❿ Main Power Switch

On/off Switch to turn main power on/off.

Control Key Lock Mode

This control completely locks out access to all Control Key functions. To activate the control key lock function, press both of "▼" and "▲" and hold down simultaneously for more than 3 seconds. To resume back to user mode, press both of "▼" and "▲" and hold simultaneously for more than 3 seconds.

Terminal Panel

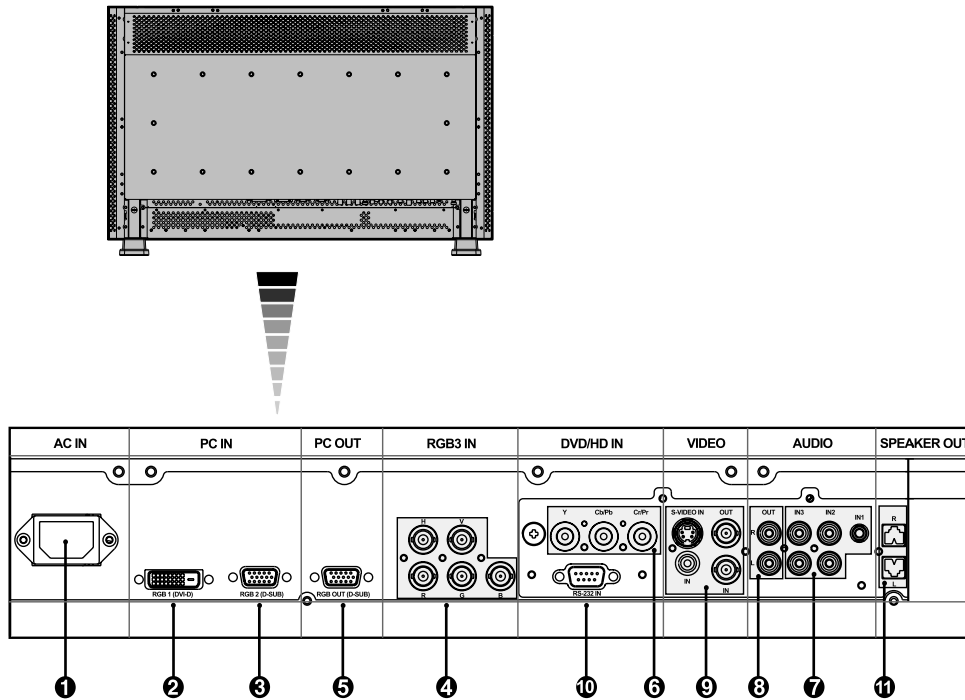

❶ AC IN connector

Connects with the supplied power cord.

❷ RGB 1 IN (DVI-D)

To input digital RGB signals from a computer.

* This connector does not support analog input.

❸ RGB 2 IN (mini D-Sub 15 pin)

To input analog RGB signals from a personal computer or other RGB equipment.

❹ RGB 3 IN [R, G, B, H, V] (BNC)

To input analog RGB signals from a computer or other RGB equipment.

❺ RGB OUT (mini D-Sub 15 pin)

To output the signal from RGB 2 or 3.

❻ DVD/HD IN (BNC)

Connecting equipment such as a DVD player, HDTV device, or Laser disc player.

❼ AUDIO IN 1, 2, 3

To input audio signal from external equipment such as a computer, VCR or DVD player.

❽ AUDIO OUT

To output the audio signal from the AUDIO IN 1, 2 and 3 jack.

❾ VIDEO IN/OUT

VIDEO IN connector (BNC and RCA): To input a composite video signal. BNC and RCA connectors are not available at the same time. (Use only one input).

VIDEO OUT connector (BNC): To output the composite video signal from the VIDEO IN connector.

S-VIDEO IN connector (DIN 4 pin): To input the S-video (Y/C separate signal). See page 25, S-VIDEO MODE SETTING.

❿ EXTERNAL CONTROL (mini D-Sub 9 pin)

Use when operating the LCD monitor from the RGB equipment like a computer.

⓫ EXTERNAL SPEAKER TERMINAL

To output the audio signal from AUDIO 1, 2 or 3 jack.

Wireless Remote Control

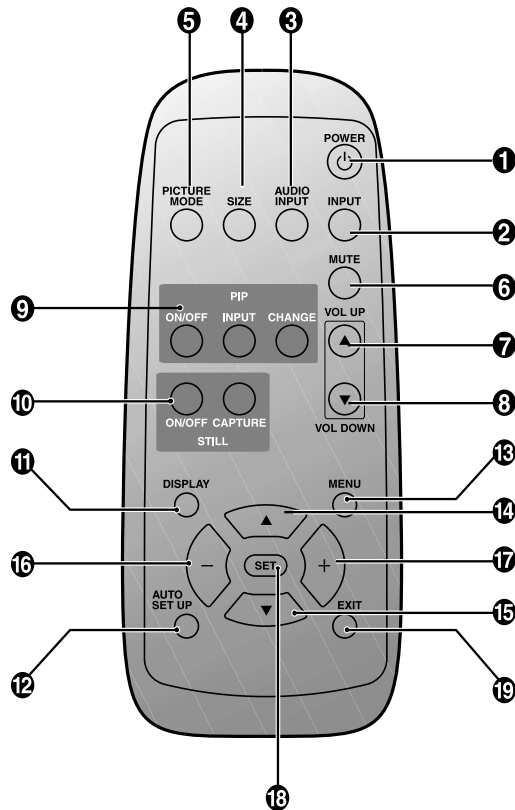

1 POWER button

Switches the power on/off.

* If Power Indicator is not glowing, then no controls will work.

2 INPUT button

Selects from input signal, [RGB1], [RGB2], [RGB3], [DVD/HD], [VIDEO] and [VIDEO<S>]. [VIDEO<S>] is enabled by selecting the "SEPARATE" mode in the OSD or by having the "S-VIDEO" cable connected with the "S-VIDEO" signal present and selecting "PRIORITY" MODE. See page 25.

3 AUDIO INPUT button

Selects from input audio signal, [AUDIO1], [AUDIO2], [AUDIO3].

4 SIZE button

Selects picture size, [FULL], [NORMAL], [WIDE] and [ZOOM]. See page 18.

5 PICTURE MODE button

Selects from picture mode, [HIGHBRIGHT], [STANDARD], [sRGB], [CINEMA]. See page 18.

HIGHBRIGHT: for moving images such as DVD

STANDARD: for images (Factory Setting)

sRGB: for text based images

CINEMA: for movies.

6 MUTE button

To switch the mute function on/off.

7 VOLUME UP button

Increases the audio output level.

8 VOLUME DOWN button

Decreases the audio output level.

9 PIP (Picture In Picture) button

ON/OFF button: PIP ON/OFF. See page 22.

INPUT button: Selects the "picture in picture" input signal.

CHANGE button: Replaces to the main picture and sub picture.

10 STILL button

ON/OFF button: To switch the still picture mode on/off.

CAPTURE button: Updates the still picture.

11 DISPLAY button

To switch the information OSD on/off. See page 18.

12 AUTO SETUP button

To enter the auto setup menu. See page 22.

13 MENU button

To switch the menu mode on/off.

14 UP button

Acts as ▲ button to move the highlighted area up to select the adjustment with OSD menu.

Small screen which adjusted "PIP" mode moves up.

15 DOWN button

Acts as ▼ button to move the highlighted area down to select the adjustment with OSD menu.

Small screen which adjusted "PIP" mode moves down.

16 MINUS button decrease

Acts as (-) button to decrease the adjustment with OSD menu.

Small screen which adjusted "PIP" mode moves left.

17 PLUS button increase

Acts as (+) button to increase the adjustment with OSD menu.

Small screen which adjusted "PIP" mode moves right.

18 SET button

Acts as SET button with OSD menu.

19 EXIT button

Turn to previous menu with OSD menu.

Operating Range for the Remote Control

Point the top of the remote control toward the LCD monitor's remote sensor during button operation.

Use the remote control within a distance of about 7 m/23 ft. from the front of the LCD monitor's remote control sensor and at a horizontal and vertical angle of within 30° within a distance of about 3 m/10 ft.

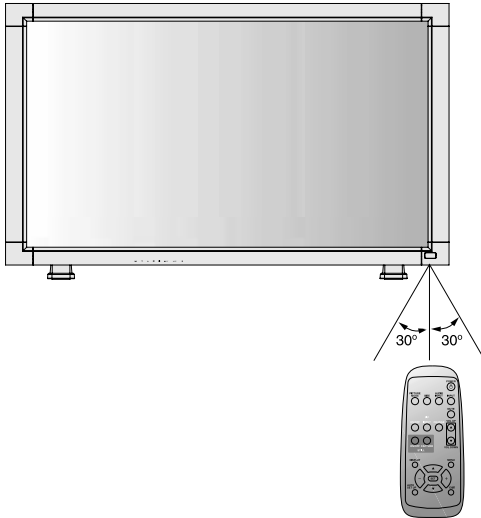

Handling the remote control

- * Do not subject to strong shock.
- * Do not allow water or other liquid to splash the remote control. If the remote control gets wet, wipe it dry immediately.
- * Avoid exposure to heat and steam.
- * Other than to install the batteries, do not open the remote control.

Caution: Important, the remote control system may not function when direct sunlight or strong illumination strikes the remote control sensor of the LCD monitor, or when there is an object in the path.

Setup Procedure

1. Determine the installation location

CAUTION: DO NOT ATTEMPT TO INSTALL THE LCD MONITOR BY YOURSELF.

Installing your LCD display must be done by a qualified technician. Contact your dealer for more information.

CAUTION: MOVING OR INSTALLING THE LCD MONITOR MUST BE DONE BY TWO OR MORE PEOPLE.

Failure to follow this caution may result in injury if the LCD monitor falls.

CAUTION: Do not mount or operate the display upside down, face up, or face down.

CAUTION: This LCD has a temperature sensor and cooling fan. If the LCD becomes too hot, the cooling fan will turn on automatically. If the LCD becomes overheated and the cooling fan is running, the "Caution" menu will appear. If the "Caution" menu appears, discontinue use and allow the unit to cool. When the LCD monitor is used in an enclosure or with protection on LCD surface, please check the inside temperature of monitor by "HEAT STATUS" (See page 26). The temperature is too hot than normal condition, please set "cooling fan" to ON on SCREEN SAVER function (See page 23).

IMPORTANT: Lay the protective sheet, which was wrapped around the LCD monitor when it was packaged, beneath the LCD monitor so as not to scratch the panel.

2. Install the remote control batteries

The remote control is powered by 1.5V AA batteries. To install or replace batteries:

1. Press and slide to open the cover.
2. Align the batteries according to the (+) and (-) indications inside the case.
3. Replace the cover.

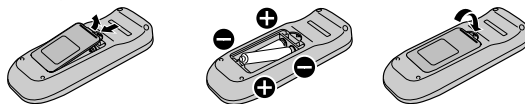

CAUTION: Incorrect use of batteries can result in leaks or bursting.

Be careful especially about the following points.

- Place "AA" size batteries matching the + and - signs on each battery to the + and - signs of the battery compartment.
- Don't mix battery types.
- Don't combine new batteries with used ones. It causes shorter battery life or leakage of batteries.
- Remove dead batteries immediately to prevent battery liquid from leaking into the battery compartment. Don't touch exposed battery acid, it cause damage to your skin.

NOTE: If you do not intend to use the Remote Control for a long period, remove the batteries.

3. Connect external equipment (See pages 12-16)

- To protect the connected equipment, turn off the main power before making connections.
- Refer to your equipment user manual.

4. Connect the supplied power cord

- The power outlet socket should be installed as near to the equipment as possible, and should be easily accessible.
- Fully insert the prongs into the power outlet socket. Loose connection may cause noise.
- Please fix the power cord by attaching the screw and clamper.

NOTE: Please refer to "Safety Precautions, Maintenance & Recommended Use" section of this manual for proper selection of AC power cord.

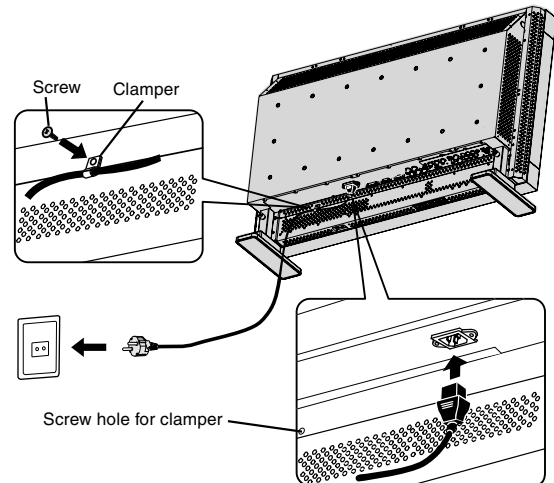

5. Switch on the power of all attached external equipment

When connected with a computer, switch on the power of the computer first.

6. Operate the attached external equipment

Display the signal on the external equipment you wish.

7. Adjust the sound

Make adjustments when adjustment of the volume is required.

8. Adjust the screen (See pages 19-26)

Make adjustments when adjustment of the screen display position or distortion is required.

9. Adjust the image (See pages 19-26)

Make adjustments when picture adjustment such as the brightness or contrast is required.

10. Recommended Adjustment

To reduce the risk of "image persistence", please adjust the following items based on the application being used.

"SCREEN SAVER" (See page 23), "SIDE BORDER COLOR" (See page 23), "DATE & TIME" (See page 26), "SCHEDULE" (See page 26).

11. When the monitor is installed in the portrait position

- Remove the stands (feet).
- Left edge should be the upper edge from front view.

12. Installing and removing stand

How to install stand

1. Please turn monitor off.
2. Place stand onto monitor with the long ends of the feet in front of the monitor.
3. After inserting stand in guide block, fasten thumbscrews on both sides of the monitor.

How to remove the stand

1. Spread the protective sheet on the flat surface, such as a desk.
2. Place monitor on the protective sheet.
3. Remove thumbscrews with a screwdriver or with your fingers and place them in a safe place for reuse.

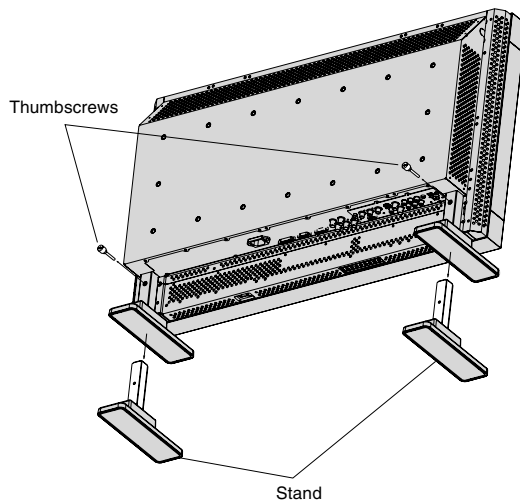

NOTE: Place stand onto monitor so that the long end of the feet are in the front.

CAUTION: Handle with care when mounting the display stand and avoid pinching your fingers.

13. When using external speakers

We recommend to using the option speakers designed for the MDT321S.

The external speaker terminals of the MDT321S may be connectable with the speaker plug of a mainframe sound speaker.

If this case, please exchange the lead connector of a mainframe sound speaker for an attached speaker plug.

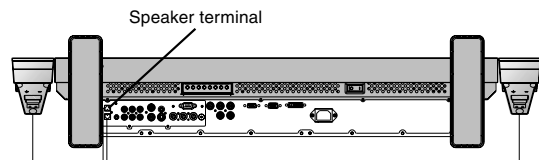
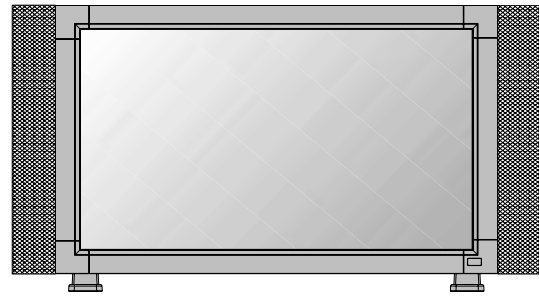

How to use the attached speaker plug

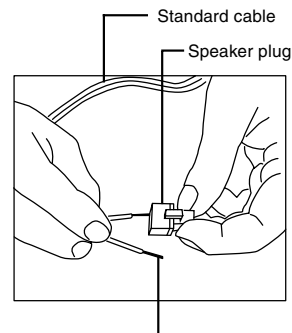

Insert the negative (-) side of a standard speaker cable into the negative (-) side of the speaker plug. The negative side of a standard speaker cable has a stripe running the length of the cable. Insert remaining wire into the positive (+) side of the speaker plug. Hold down on the small lever on the speaker plug to insert cable.

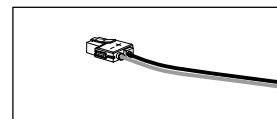

Fixed cable and speaker plug.

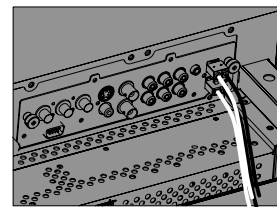

Insert the fixed cable and speaker plug to the speaker terminal.

How to Mount and Attach Options to the LCD Monitor

You can attach mounting accessories to the LCD monitor in one of the following two ways:

1. In the upright position

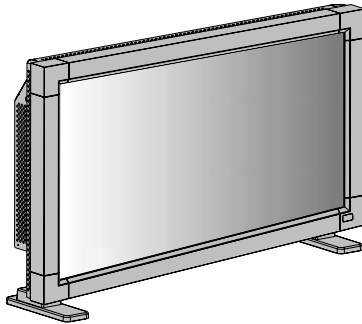

2. Lay the screen face down

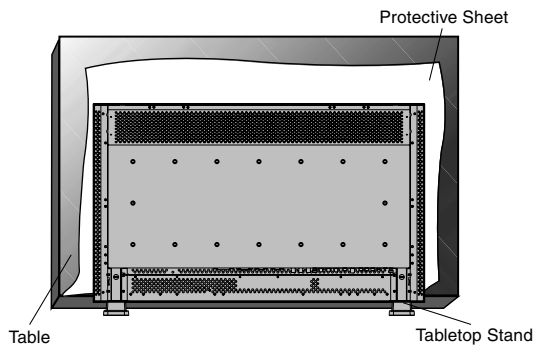

Lay the protective sheet on a table, which was wrapped around the monitor when it was packaged, beneath the screen surface so as not to scratch the screen face.

This device cannot be used or installed without the Tabletop Stand or other mounting accessory. Failure to follow correct mounting procedures could result in damage to the equipment or injury to the user or installer. Product warranty does not cover damage caused by improper installation. Failure to follow these recommendations could result in voiding your warranty.

When using with other mounting accessory, it must be a VESA-compatible mounting method and the screws must be M6 of size and 10mm or longer of length under consideration of the thickness of the mounting method. (Recommended torque: 470 - 550N•cm). MITSUBISHI ELECTRIC recommends using mounting interface that comply with TÜV-GS and/or UL1678 standard in North America.

3. Ventilation Requirements for enclosure mounting

To allow heat to disperse, leave space between surrounding objects as shown in the diagram below.

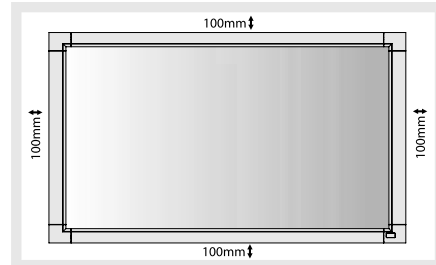

4. To avoid falling down

Fasten the LCD monitor to wall using a cord or chain, which is sufficient to support the weight of the LCD monitor (approx. 16.4kg).

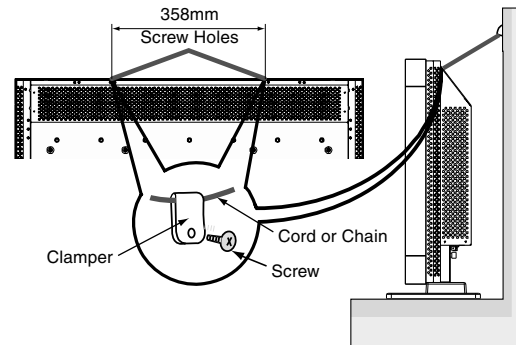

Before moving the LCD monitor, the cord or chain should be removed.

5. To prevent the main power switch from being changed

To prevent the ability to use the main power switch, please attach the main switch, which is enclosed as an accessory.

NOTE: With the main power switch cover in place, the main power switch cannot be turned off. Remove main power switch cover in order to switch off the display.

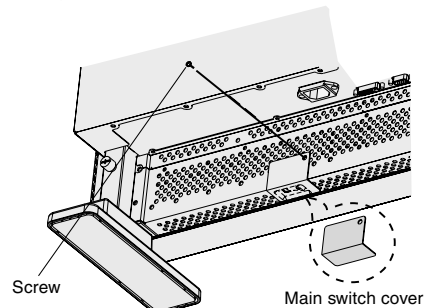

Connections

Before making connections:

- * First turn off the power of all the attached equipment and make connections.
- * Refer to the user manual included with each separate piece of equipment.

Wiring Diagram

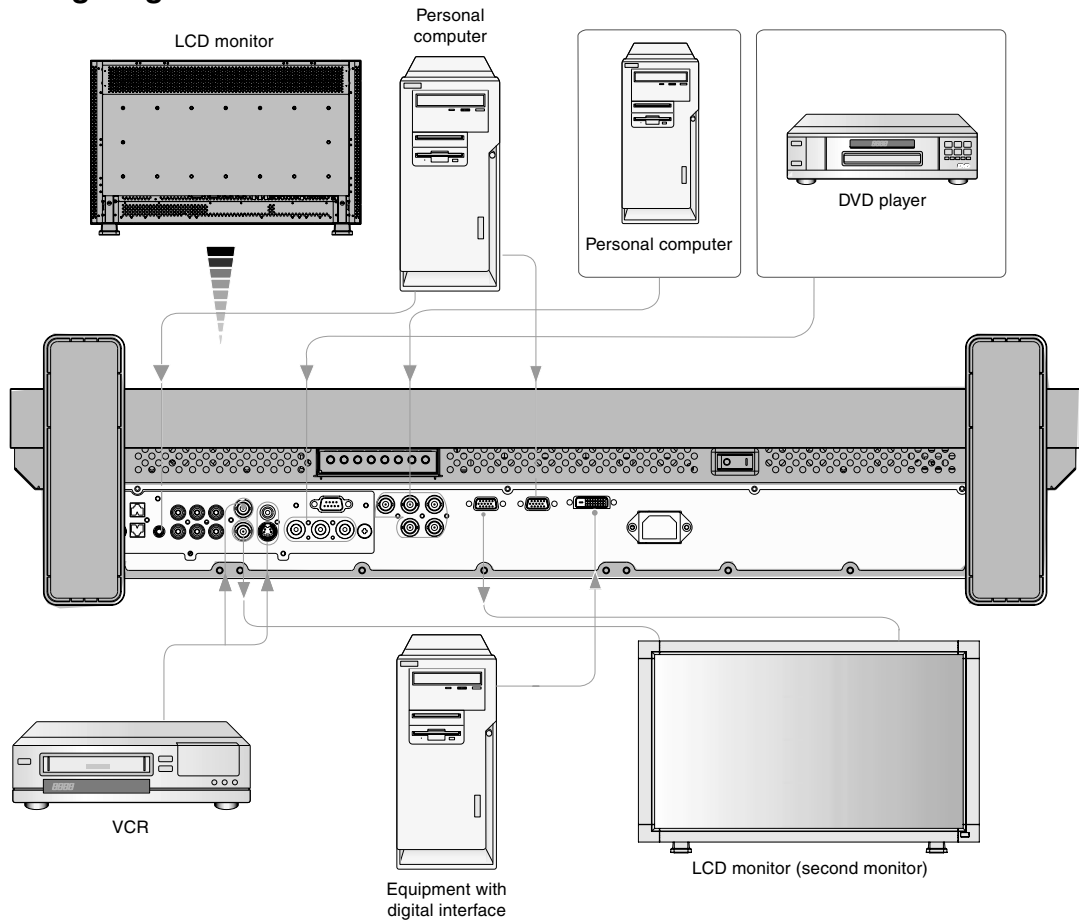

<p>Attaching the Ferrite Core</p> <p>Attach the Ferrite Core to PC Audio Cable. Use of the cable without mounting the ferrite core will result in the occurrence of noise.</p>	<p>Mounting Position of Ferrite Core</p>
<p>For PC Audio Cable</p> <p>① Open the ferrite core and clamp it on the PC Audio cable. ② Close the ferrite core.</p> <p>Ferrite Core</p>	<p>Attach the two Ferrite Cores to the both ends of PC Audio Cable.</p>

Connecting a Personal Computer

Connecting your computer to your LCD monitor will enable you to display your computer's screen image.

Some video cards may not display an image correctly.

Resolution	Scanning frequency		Remarks
	Horizontal	Vertical	
640 x 480	31.5kHz	60Hz	
800 x 600	37.9kHz	60Hz	
1024 x 768	48.4kHz	60Hz	
1280 x 768	48kHz	60Hz	
1360 x 768	48kHz	60Hz	Recommended resolution
1280 x 1024	64kHz	60Hz	Compressed image
1600 x 1200	75kHz	60Hz	Compressed image

Connect the LCD Monitor to a Personal Computer

- To connect the RGB 2 IN connector (mini D-sub 15 pin) on the LCD monitor, use the supplied PC - Video RGB signal cable (mini D-sub 15 pin to mini D-sub 15 pin).
- To connect the RGB 3 connector (BNC) on the LCD monitor, use a signal cable which is available separately (mini D-sub 15 pin to BNC x 5). Select RGB 3 from the INPUT button.
- When connecting one or more LCD monitors, use the RGB OUT connector (mini D-sub 15 pin).
- The AUDIO IN 1, 2 and 3 can be used for audio input. For connection, select AUDIO 1, 2 or 3 from the AUDIO INPUT button.

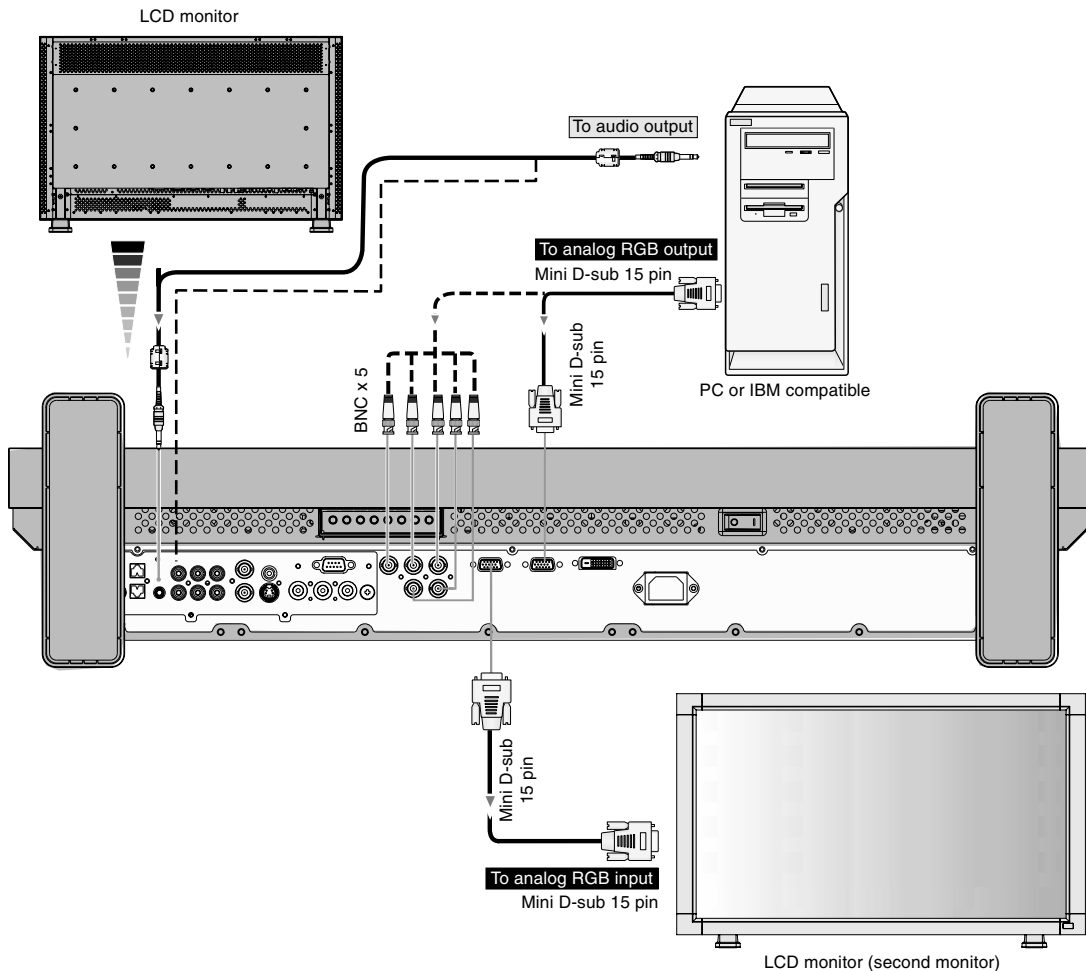

English-13

Connecting with Digital Interface Equipment

Connections can be made with equipment that is equipped with a digital interface compliant with the DVI (Digital Visual Interface) standard.

Connect the LCD Monitor to a Computer with a Digital Output

- The RGB 1 IN connector also accepts a DVI-D cable.
- Input TMDS signals conforming to DVI standards.
- To maintain display quality, use a cable with a quality prescribed by DVI standards.
- The AUDIO IN 1, 2 and 3 can be used for audio input. For connection, select AUDIO 1, 2 or 3 from the AUDIO INPUT button.

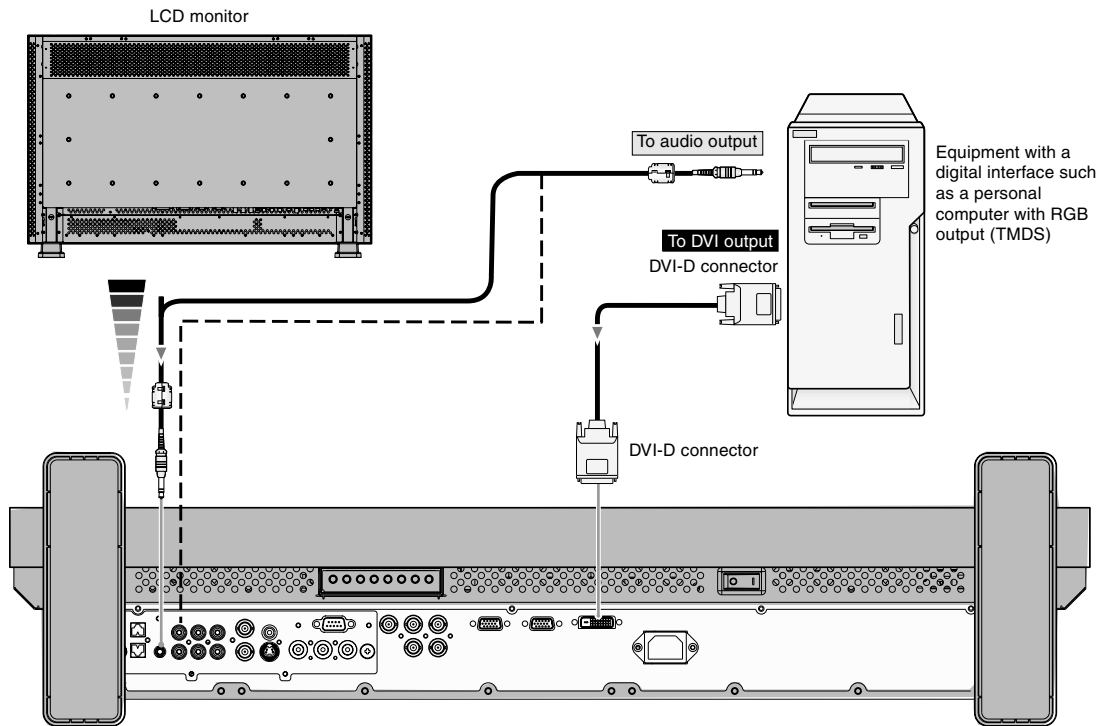

Connecting a DVD Player with component out

Connecting your DVD player to your LCD monitor will enable you to display DVD video. Refer to your DVD player user's manual for more information.

Connect the LCD Monitor to a DVD Player

- To connect the DVD/HD IN connector (BNC) on the LCD monitor, use a separately available BNC connector cable. You will need a BNC-to-RCA adapter to connect a DVD player with an RCA pin jack to the BNC connector cable (not provided). The AUDIO IN 2 and 3 (both RCA) can be used for audio input. For connection, select [AUDIO 2] or [AUDIO 3] from the AUDIO INPUT button.

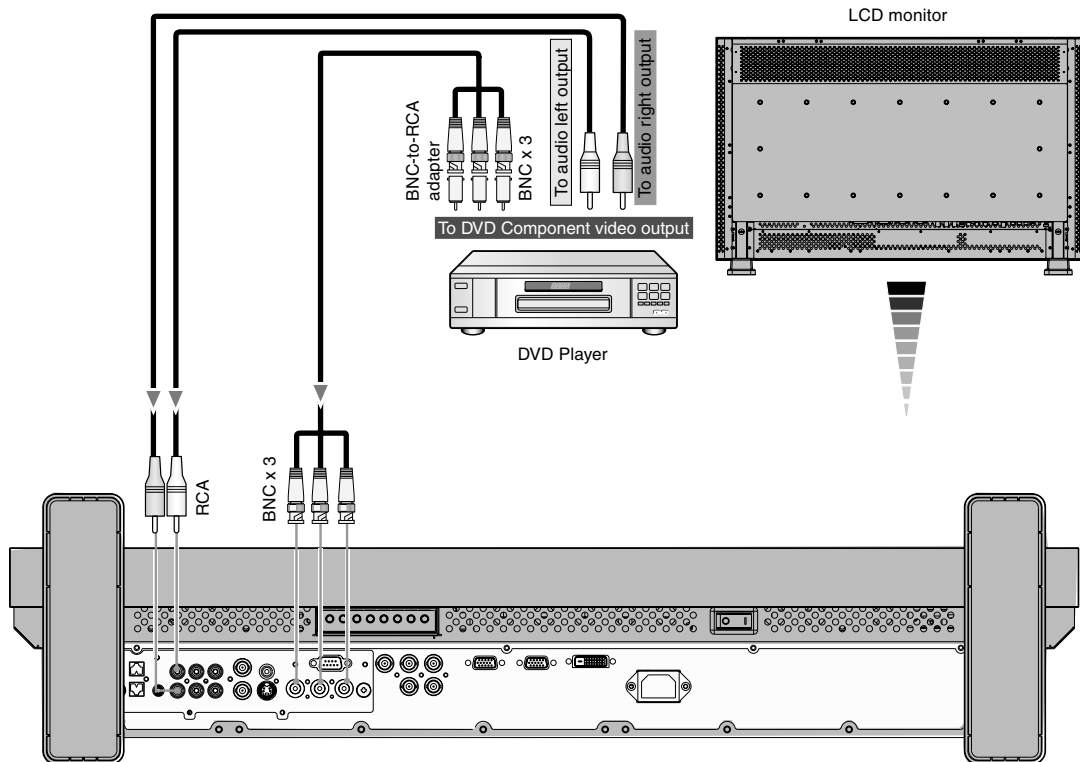

Connecting to a Stereo Amplifier

You can connect your stereo amplifier to your LCD monitor. Refer to your amplifier owner's manual for more information.

Connect the LCD Monitor to a Stereo Amplifier

- Turn on the LCD monitor and the amplifier only after all connections have been made.
- Use an RCA cable to connect the AUDIO OUT connector (RCA) on the LCD monitor and the audio input on the amplifier.
- Do not reverse the audio left and right jacks.
- The AUDIO IN is used for audio input.
- The AUDIO OUT jack outputs sound from the selected Audio input.

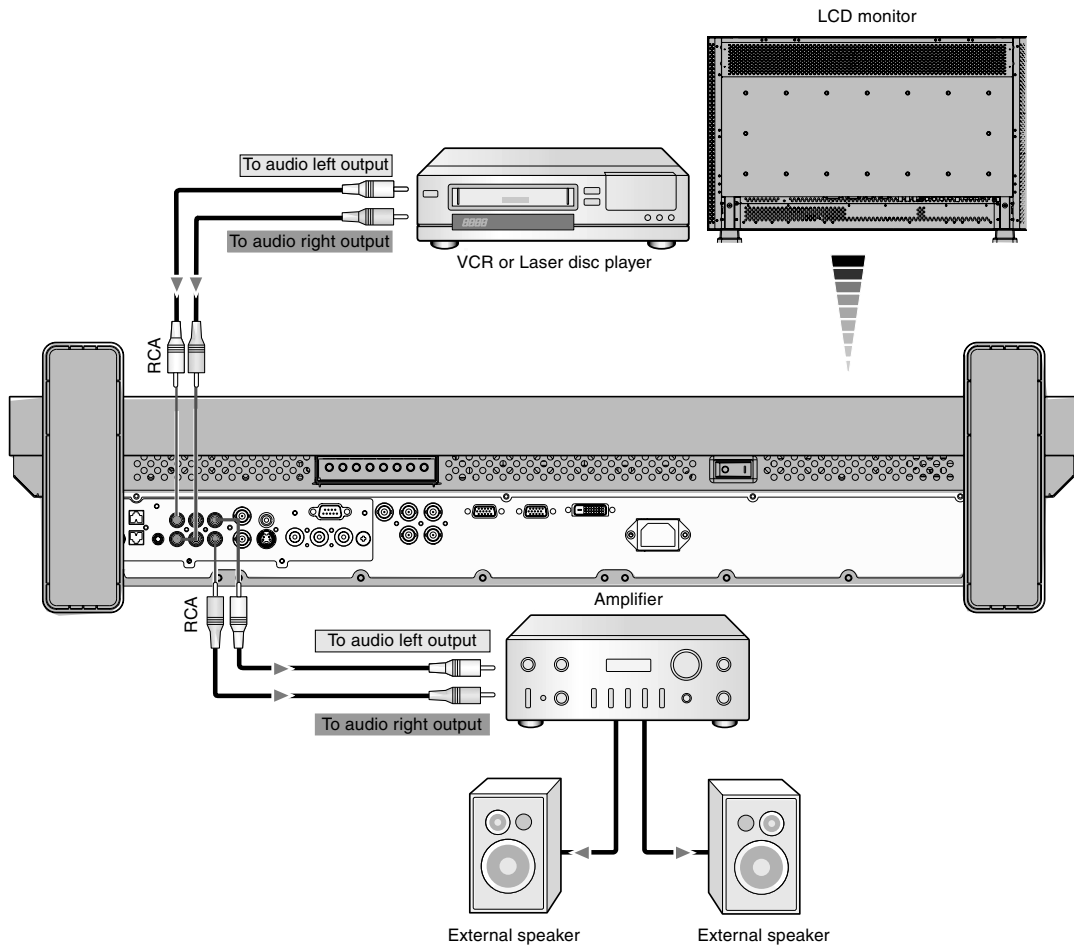

Basic Operation

Power ON and OFF Modes

The LCD monitor power indicator will turn green while powered on, or red when in off mode. The monitor can be powered on or off using the following three options:

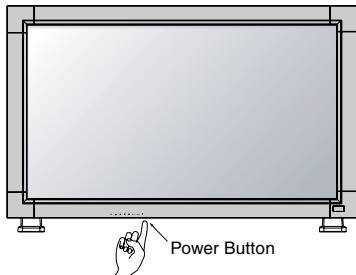

1. Pressing the power button.

Note: Before pressing the power button, be sure to turn on the Main Power Switch on the LCD monitor.

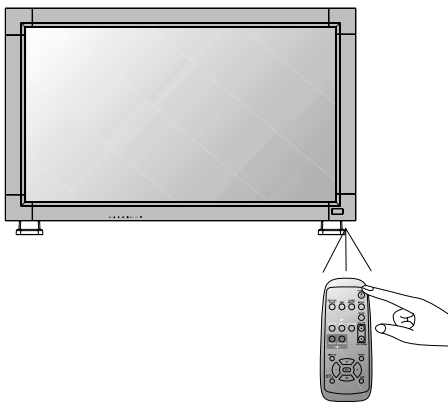

2. Using the remote control.

Note: Before operating the remote control, be sure to turn on the Main Power Switch on the LCD monitor.

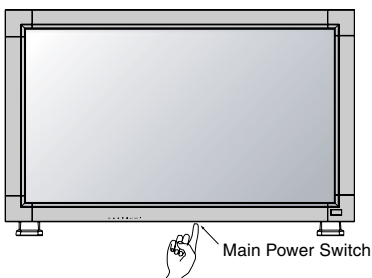

3. Pressing the Main Power Switch.

Note: When the Main Power Switch is used to power off the LCD, the remote control and the power button will not activate the on mode and both green and red power indicator turn off. Be sure to turn the Main Power Switch to the on mode before using these two options.

Power Indicator

	Status
Power ON	Green
Power OFF	Red
Power Standby when "SCHEDULE" is enable	Red On Green Blinking
Power Standby	Red, Green
Diagnosis (Detecting failure)	Red Blinking * See troubleshooting on page 31

Using Power Management

The LCD monitor follows the VESA approved DPM Power Management function.

The power management function is an energy saving function that automatically reduces the power consumption of the display when the keyboard or the mouse has not been used for a fixed period.

The power management feature on your new display has been set to the "ON" mode. This allows your display to enter a Power Saving Mode when no signal is applied. This could potentially increase the life and decrease the power consumption of the display.

Selecting a video source

To view a video source:

Use the input button to set [VIDEO].

Use the COLOR SYSTEM menu to set [AUTO], [NTSC], [PAL], [SECAM], [PAL60], [4.43NTSC], according to your video format.

Picture Size

RGB 1, 2, 3 FULL → ZOOM → NORMAL
 DVD/HD, VIDEO FULL → WIDE → ZOOM → NORMAL

Signal Type	NORMAL SIZE	Recommended Size
4:3		NORMAL
		ZOOM (DYNAMIC)
Squeeze		FULL
Letter box		WIDE

NORMAL: Display by the inputted signal aspect ratio by PC signal, or display in 4:3 aspect ratio at DVD/HD or VIDEO signal.
 FULL: Display in entire screen.

WIDE: Expand 16:9 letter box signal to entire screen.

ZOOM (DYNAMIC): Expand 4:3 pictures to the entire screen with non-linearity. (Some around image will be cut by expansion.)

ZOOM

Image can be expanded beyond the active display area. The image which is outside of active display area is not displayed.

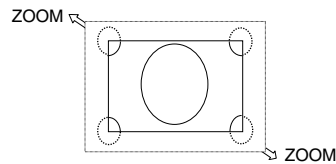

Picture Mode

RGB 1, 2, 3 HIGHBRIGHT → STANDARD → sRGB
 DVD/HD, VIDEO HIGHBRIGHT → STANDARD → CINEMA

Information OSD

RGB1, 2, 3

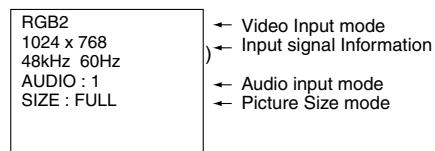

DVD/HD

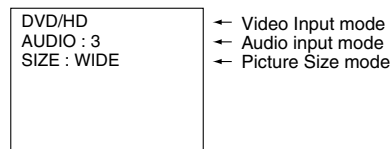

VIDEO

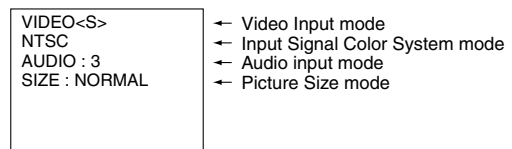

PIP

Main:RGB2
 Sub:VIDEO<S>

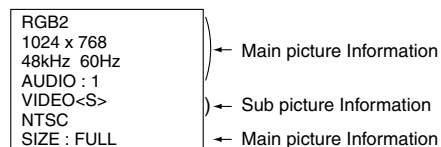



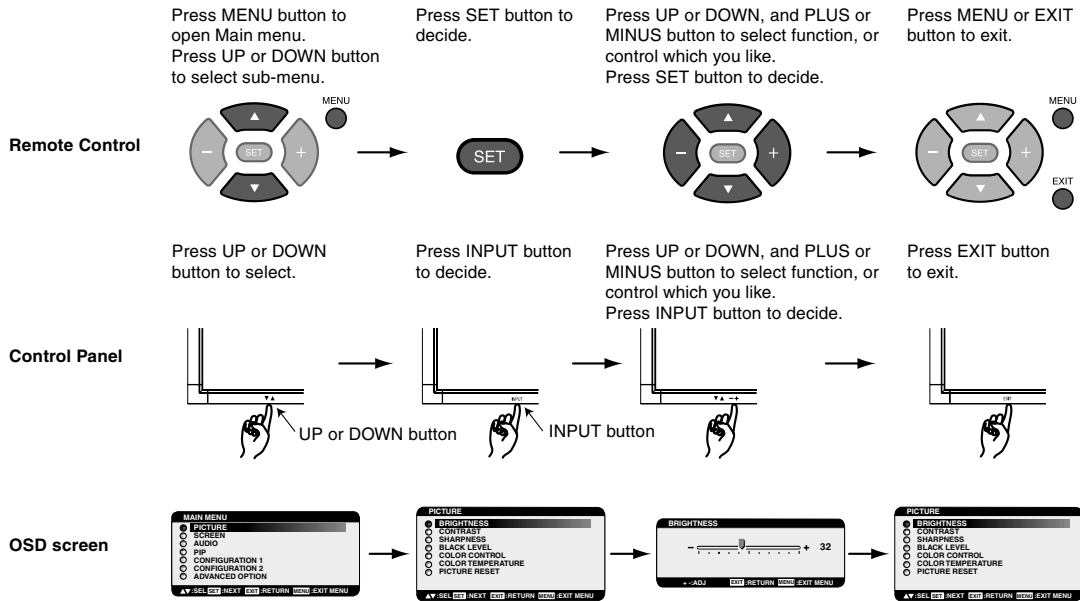





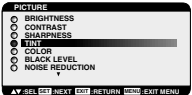

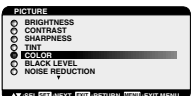

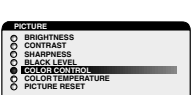
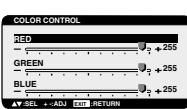
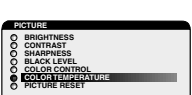
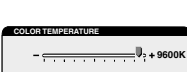
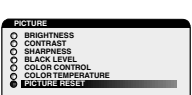

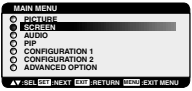
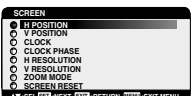

OSD (On-Screen-Display) Controls

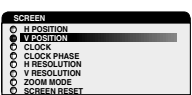

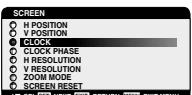

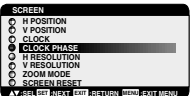

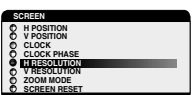



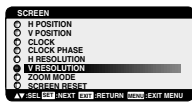
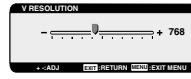

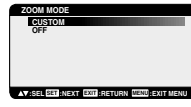
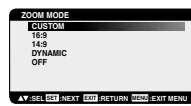
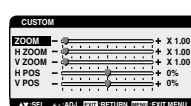
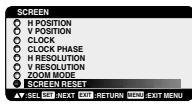

Main-Menu		PICTURE	
		Sub-Menu	
BRIGHTNESS		Adjusts the overall image and background screen brightness. Press + button to increase brightness. Press - button to decrease brightness.	
CONTRAST		Adjusts the image contrast in relation to the input signal. Press + button to increase contrast. Press - button to decrease contrast. NOTE: sRGB picture mode is standard and cannot be changed.	
SHARPNESS		This function is digitally capable to keep crisp image at any timing. It is adjustable to get a distinct image or a soft one as you prefer and set independently for each picture mode. Press + button to increase sharpness. Press - button to decrease sharpness.	
BLACK LEVEL		Adjusts the image brightness in relation to the background. Press + button to increase black level. Press - button to decrease black level. NOTE: sRGB picture mode is standard and cannot be changed.	
NOISE REDUCTION		Adjusts the noise reduction level. Press + button to increase reduction level. Press - button to decrease reduction level.	

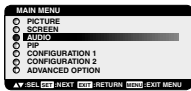





*:INPUT VIDEO only









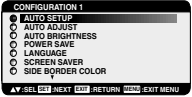

<p>TINT</p> <p>*:INPUT DVD/HD, VIDEO only</p>			<p>Adjust the tint of the screen.</p> <p>Press + button to Skin color becomes greenish. Press - button to Skin color becomes purplish.</p>
<p>COLOR</p> <p>*:INPUT DVD/HD, VIDEO only</p>			<p>Adjust the color depth of the screen.</p> <p>Press + button to increase color depth. Press - button to decrease color depth.</p>
<p>COLOR CONTROL</p> <p>*:INPUT RGB1,2,3 only</p>			<p>R, G, B: Increases or decreases Red, Green and Blue, depending upon which is selected. The change in color will appear on screen and the direction (increase or decrease) will be shown by the color bars.</p> <p>NOTE: sRGB picture mode is standard and cannot be changed.</p>
<p>COLOR TEMPERATURE</p>			<p>To adjust the color temperature of entire screen.</p> <p>Adjusting lower color temperature makes the screen reddish and higher color temperature makes the screen bluish.</p> <p>NOTE: sRGB picture mode is standard and cannot be changed.</p>
<p>PICTURE RESET</p>			<p>Selecting Picture reset allows you to reset all OSD settings about PICTURE setting.</p> <p>Select "Yes" and press "SET" button to restore to factory preset data.</p> <p>Press "EXIT" button to cancel and then return to the previous menu.</p>

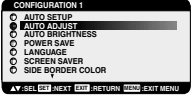

<p>Main-Menu</p>			
<p>SCREEN</p>			
<p>Sub-Menu</p>			
			
<p>H POSITION</p>			<p>Controls Horizontal Image position within the display area of the LCD.</p> <p>Press + button to move screen to right. Press - button to move screen to left.</p>
<p>V POSITION</p>			<p>Controls Vertical Image position within the display area of the LCD.</p> <p>Press + button to move screen to UP. Press - button to move screen to DOWN.</p>
<p>CLOCK</p> <p>*:INPUT RGB2/3 only</p>			<p>Press + button to expand the width of the image on the screen to the right. Press - button to narrow the width of the image on the screen to the left.</p>
<p>CLOCK PHASE</p> <p>*:INPUT RGB2/3, DVD/HD only</p>			<p>Improves focus, clarity and image stability by increasing or decreasing this setting.</p>
<p>H RESOLUTION</p> <p>*:INPUT RGB1/2/3 only</p>			<p>Adjusts the horizontal size by increasing or decreasing the setting.</p> <p>Press + button to expand the width of the image on the screen. Press - button to narrow the width of the image on the screen.</p>

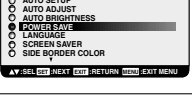
<p>V RESOLUTION</p> <p>*:INPUT RGB1/2/3 only</p>	 	<p>Adjusts the vertical size by increasing or decreasing the setting.</p> <p>Press + button to expand the height of the image on the screen.</p> <p>Press - button to narrow the height of the image on the screen.</p>
<p>ZOOM MODE</p>	  <p>*:INPUT RGB1/2/3 only</p>  <p>*:INPUT DVD/HD, VIDEO only</p> 	<p>Selects the screen zoom mode. Zoom mode will be selected when you select the "ZOOM" by pushing the "SIZE" button on remote controller.</p> <p>When you select the "CUSTOM", you will be able to adjust optional horizontal and vertical size.</p> <p>You can also select 16:9, 14:9 and DYNAMIC. (INPUT DVD/HD,VIDEO only)</p> <p>Press "SET" button to show a control menu as follows:</p> <p>Increase or decrease "ZOOM" slider to adjust the whole size and then adjust horizontal and vertical size by H ZOOM and V ZOOM. Increase or decrease "H POS" and "V POS" to adjust the picture position.</p> <p>Selecting "DYNAMIC" will expand 4:3 pictures to the entire screen with non-linearity. (Some around image will be cut by expansion.) Dynamic image is the same as FULL size image when HDTV 1080i or 720p signal is input.</p> <p>Selecting "OFF" image will be displayed 1 by 1 pixel. (If you input over 1366x768 resolution signal, it will be displayed as shrank image.)</p>
<p>SCREEN RESET</p>	 	<p>Selecting Screen reset allows you to reset all OSD settings from SCREEN setting.</p> <p>Select "Yes" and press "SET" button to restore the factory preset data.</p> <p>Press "EXIT" button to cancel and then return to the previous menu.</p>

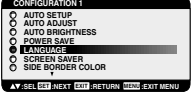



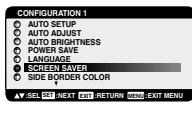

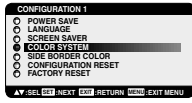
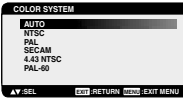
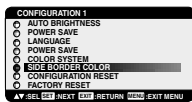
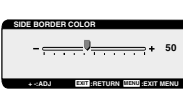
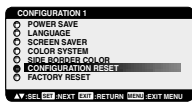
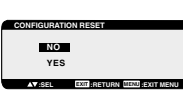
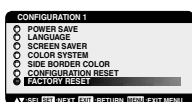
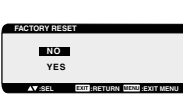

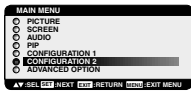
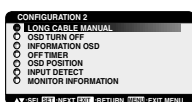
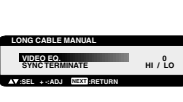
<p>Main-Menu</p> <p>AUDIO</p> <p>Sub-Menu</p>		
<p>BALANCE</p>	 	<p>Adjust the balance of L/R volume.</p> <p>Press + button to move the stereo sound image to right. Sound of the left side will be small.</p> <p>Press - button to move the stereo sound image to left.</p>
<p>TREBLE</p>	 	<p>To accentuate or reduce the high frequency sound.</p> <p>Press + button to increase TREBLE sound.</p> <p>Press - button to decrease TREBLE sound.</p>
<p>BASS</p>	 	<p>To accentuate or reduce the low frequency sound.</p> <p>Press + button to increase BASS sound.</p> <p>Press - button to decrease BASS sound.</p>
<p>AUDIO RESET</p>	 	<p>Selecting Audio reset allows you to reset all OSD settings from AUDIO setting.</p> <p>Select "Yes" and press "SET" button to restore the factory preset.</p> <p>Press "EXIT" button to cancel and then return to the previous menu.</p>

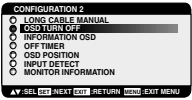

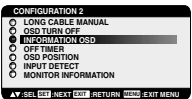

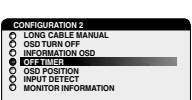

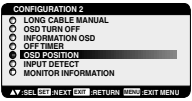
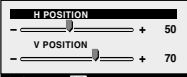
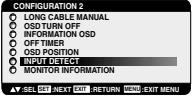
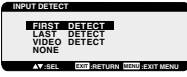
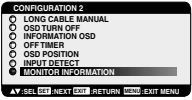



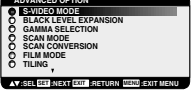

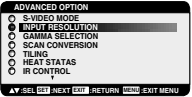

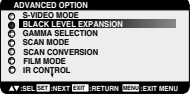
Main-Menu		
PICTURE IN PICTURE		
Sub-Menu		
PIP SIZE	 	<p>Selecting the size of picture inserted at the "Picture-in-Picture" (PIP) mode.</p> <p>"Large", "Middle" and "Small" are available.</p>
PIP AUDIO	 	<p>Selecting the sound source in PIP mode.</p> <p>When selecting "MAIN AUDIO", you will get the sound for the main picture and when selecting "PIP AUDIO", you will get the sound for the picture instead.</p>
PIP RESET	 	<p>Selecting PIP Reset allows you to reset all OSD settings from PIP setting.</p> <p>Select "Yes" and press "SET" button to restore the factory preset data.</p> <p>Press "EXIT" button to cancel and then return to the previous menu.</p>

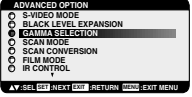
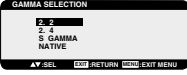
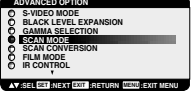

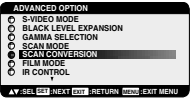
Main-Menu		
CONFIGURATION 1		
Sub-Menu		
AUTO SETUP *:INPUT RGB2/3 only	 	<p>Press "SET" button to automatically adjust screen size, horizontal position, vertical position, clock, clock phase, white level and black level.</p> <p>Press "EXIT" button to cancel execution AUTO SETUP and then will return to the previous menu.</p>
AUTO ADJUST *:INPUT RGB2/3 only	 	<p>Selecting the auto adjust ON/OFF.</p> <p>Selecting ON when changing the timing, the horizontal position, vertical position and clock-phase will adjust automatically according to input signal.</p>
AUTO BRIGHTNESS *:INPUT RGB1/2/3 only	 	<p>Selecting the auto brightness ON/OFF.</p> <p>When select "ON", the brightness will be automatically adjusted.</p>
POWER SAVE	 	<p>Selecting RGB "ON", the monitor will go to power management mode when RGB1,2,3 sync is lost.</p> <p>Selecting VIDEO "ON", the monitor will go to power management mode after about 10 minutes delay from when DVD/HD and VIDEO input signal is lost.</p>
LANGUAGE	 	<p>OSD control menus are available in seven languages.</p>

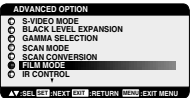
<p>SCREEN SAVER</p>	 	<p>Select "SCREEN SAVER" functions to reduce the risk of the "image persistence". GAMMA: The display gamma is changed and fixed when selected "ON". COOLING FAN: The built in cooling fan is always on when set "ON". BRIGHTNESS: The brightness is decreased when selected "ON". MOTION: Image is slightly expanded and moves 4 directions (UP, DOWN, RIGHT, LEFT) periodically (Need setting the time for movement). Movement area is approximately +/- 10mm from original position; Please locate the important information such as text within 90% area of screen image. See note (1) for this functions. PIP and STILL will be disabled when "MOTION" is active.</p>
<p>COLOR SYSTEM *:INPUT VIDEO only</p>	 	<p>Selecting the Color System depends on your input video format. AUTO: NTSC, PAL, SECAM, PAL60 or 4.43 NTSC is automatically selected. NTSC: Specific selection of NTSC. PAL: Specific selection of PAL. SECAM: Specific selection of SECAM. PAL-60: Specific selection of PAL60. 4.43NTSC: Specific selection of 4.43 NTSC.</p>
<p>SIDE BORDER COLOR</p>	 	<p>Adjustment the side black bar color white when 4:3 image displayed, black to white. Press + button, the bar will become whiter. Press - button, the bar will become darker.</p>
<p>CONFIGURATION RESET</p>	 	<p>Selecting the CONFIGURATION RESET allows you to reset all configuration settings. Select "Yes" and press "SET" button to restore the factory preset data. Press "EXIT" button to cancel and return the previous menu.</p>
<p>FACTORY RESET</p>	 	<p>Selecting "YES" allows you to reset PICTURE, SCREEN, AUDIO, CONFIGURATION1,2 and ADVANCED OPTION will be back to factory settings (except LANGUAGE, DATE & TIME and SCHEDULE). Select "YES" and press "SET" button to restore the factory preset data. Press "EXIT" button to cancel and return the previous menu.</p>

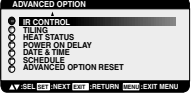
<p>Main-Menu</p> <p>CONFIGURATION 2</p> <p>Sub-Menu</p>		
<p>LONG CABLE MANUAL *:INPUT RGB2/3 only</p>	 	<p>To compensate for image degradation, which is caused by using a long cable.</p> <p>VIDEO EQ To optimize the shape (Tailing) of RED, GREEN and BLUE signal. Level: 0 - 7</p> <p>SYNC TERMINATE (Input RGB 3 only) To select the terminate resistance for matching the cable impedance. HI: 2.2K ohm/LO:75 ohm</p>

<p>OSD TURN OFF</p>	 	<p>The OSD control menu will stay on as long as it is use. In the OSD Turn Off submenu, you can select how long the monitor waits after the last touch of a button to shut off the OSD control menu. The preset choices are 10 -240 seconds.</p>
<p>INFORMATION OSD</p>	 	<p>Selects the information OSD display or not. The information OSD will display when input signal or source change or warning message like as no-signal or out-of range. A time between 3 to 10 seconds is available.</p>
<p>OFF TIMER</p>	 	<p>To select OFF TIMER mode ON/OFF. In the OFF TIMER menu, you can preset the monitor to automatically power down. A time between 1 to 24 hours is available. When the OFF TIMER is set, the SCHEDULE (see page 26) settings will be disabled.</p>
<p>OSD POSITION</p>	 	<p>Adjusts the position of the OSD menu.</p>
<p>INPUT DETECT</p>	 	<p>Selects the method of input detection when more than two computers are connected.</p> <p>FIRST DETECT: When the current video input signal is not present, then the monitor searches for a video signal from the other video input port. If the video signal is present in the other port, then the monitor switches the video source input port to the new found video source automatically. The monitor will not look for other video signals while the current video source is present. This function is available at input RGB 1/2/3.</p> <p>LAST DETECT: When the monitor is displaying a signal from the current source and a new secondary source is supplied to the monitor, the monitor will automatically switch to the new video source. When current video input signal is not present, the monitor searches for a video signal from the other video input port. If the video signal is present in the other port, then the monitor switches the video source input port to the new found video source automatically. This function is available at input RGB 1/2/3.</p> <p>VIDEO DETECT: DVD/HD or VIDEO inputs will have priority over RGB1/2/3. When DVD/HD or VIDEO input signal is present the monitor will change and keep to the DVD/HD or VIDEO input.</p> <p>NONE: The Monitor will not search the other video input port.</p>
<p>MONITOR INFORMATION</p>	 	<p>Indicates the model and serial number of your monitor.</p>

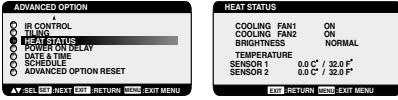
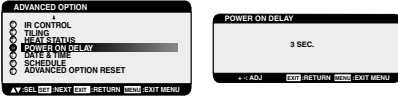
Main-Menu		
ADVANCED OPTION		
Sub-Menu		
<p>S-VIDEO MODE</p>	 	<p>Selects the S-Video input port function.</p> <p>PRIORITY: If cable is connected to the S-Video input, it will have priority the composite input port.</p> <p>SEPARATE: S-Video port and Composite port are selectable as independent input port.</p>
<p>INPUT RESOLUTION</p> <p>*:INPUT RGB2/3 only</p>	 	<p>Selects to decision of input signal about below timings, 1024x768, 1280x768 and 1360x768.</p> <p>AUTO: Determines the resolution automatically.</p> <p>1024x768: Determines the resolution as 1024x768</p> <p>1280x768: Determines the resolution as 1280x768</p> <p>1360x768: Determines the resolution as 1360x768</p>
<p>BLACK LEVEL EXPANSION</p> <p>*:INPUT VIDEO, DVD/HD only</p>	 	<p>Selects a level of black expansion.</p> <p>In case of go under the black cut-off level, please adjust the "Black level" in moderation on OSD menu.</p>
<p>GAMMA SELECTION</p>	 	<p>Selects a display gamma.</p> <p>1: 2.2 2: 2.4 3: S gamma 4: Native</p> <p>NOTE: sRGB picture mode is standard and cannot be changed.</p>
<p>SCAN MODE</p> <p>*:INPUT DVD/HD, VIDEO only</p>	 	<p>Changes the display area of the image.</p> <p>OVERSCAN: Set to display area about 95%</p> <p>UNDERSCAN: Set to display area about 100%</p>
<p>SCAN CONVERSION</p>	 	<p>Selects IP (Interlace to Progressive) converter function.</p> <p>PROGRESSIVE: Enable the IP function, to convert interlace signal to progressive. Normally use this setting.</p> <p>INTERLACE*: Disable the IP function.</p> <p>*NOTE: This mode is better suited for motion pictures, but it is in danger of image retention.</p>
<p>FILM MODE</p> <p>*:INPUT DVD/HD, VIDEO only</p>	 	<p>Selects Film mode function.</p> <p>AUTO: Enable the Film mode function. This mode is better suited for movies, which is converted 24 Frames/ sec source to DVD Video. We recommend to select "PROGRESSIVE" in "SCAN CONVERSION".</p> <p>OFF: Disable the Film mode function. This mode is better suited for Broadcasting or VCR source.</p>
<p>IR CONTROL</p>	 	<p>Selects the infrared wireless remote controller mode. The item in this menu will become effective by pressing "SET" button on the selected item.</p> <p>NORMAL: The monitor will be controlled normally by wireless remote controller.</p> <p>LOCK: Disable the monitor control by infrared wireless remote controller.</p> <p>Keep pressing "DISPLAY" button during 5 sec or more, this setting will return to "NORMAL".</p>

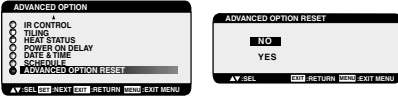
<p>TILING</p>		<p>TILING demonstrates multiple screens. This feature provides a single large screen using up to 16 monitors. It will be able to divide up to 4 each H and V. This requires you to feed the PC output into each of the monitors through a distributor.</p> <p>H MONITORS: Select number of horizontal divide. V MONITORS: Select number of vertical divide. POSITION: Select a position to expand the screen. FRAME COMP: Works in tandem with TILING to compensate for the width of the tile bezels in order to accurately display the image. ENABLE: Select "YES", the monitor will expand the selected position. PIP and STILL and "DYNAMIC" ZOOM mode will be disabled when "TILING" is activated.</p>
<p>HEAT STATUS</p>		<p>Information of status for COOLING FAN, BRIGHTNESS and TEMPERATURE. COOLING FAN comes to run when inside temperature is over a guaranteed limit. BRIGHTNESS comes to be decreased when inside temperature is over guaranteed limit with cooling fan. In this case warning is displayed on the screen.</p>
<p>POWER ON DELAY</p>		<p>Adjusts the delay time from "standby" to "power on" mode.</p> <p>"POWER ON DELAY" time is selectable between 0 and 50 sec.</p>
<p>DATE & TIME</p>		<p>Adjusts the current date and time for internal clock. You should set this function when you use "SCHEDULE".</p>
<p>SCHEDULE</p>		<p>Programs the monitor's working schedule. Schedule the power on and power off with hour and a day of the week. Also sets the input port. This OSD can't remove except EXIT. (see "NOTE 2" on page 27 for further information)</p>
<p>ADVANCED OPTION RESET</p>		<p>Selecting ADVANCED OPTION reset allows you to reset all OSD settings from ADVANCED OPTION settings, except for DATE & TIME, and SCHEDULE. Select "YES" and press "SET" button to restore the factory preset data. Press "EXIT" button to cancel and then return the previous menu.</p>

NOTE 1: IMAGE PERSISTENCE

Please be aware that LCD Technology may experience a phenomena known as Image Persistence. Image Persistence occurs when a residual or "ghost" image of a previous image remains visible on the screen. Unlike CRT monitors, LCD monitors' image persistence is not permanent, but constant images being displayed for a long period of time should be avoided.

To alleviate image persistence, turn off the monitor for as long as the previous image was displayed. For example, if an image was on the monitor for one hour and a residual image remains, the monitor should be turned off for one hour to erase the image.

As with all personal display devices, MITSUBISHI ELECTRIC recommends displaying moving images and using a moving screen saver at regular intervals whenever the screen is idle or turning off the monitor when not in use.

Please set "SCREEN SAVER", "DATE & TIME" and "SCHEDULE" functions to further reduce the risk of Image persistence.

For long life use of Public Display**< Image Sticking of LCD Panel >**

When LCD panel is operated continuously for long hours, a trace of electric charge remains near the electrode inside LCD, and residual or "ghost" image of previous image may be observed. (Image Persistence)

Image Persistence is not permanent, but when fixed image is displayed for long period, ionic impurities inside LCD are accumulated along the displayed image, and it is observed permanently. (Image Sticking)

< Recommendations >

For preventing the fast transition to Image Sticking, and for longer life usage of LCD, following are recommended.

1. Fixed image should not be displayed for long period, and changed to another images with short cycle.
2. When no use, please turn off the monitor by remote control, or use Power Management Function of monitor or use Schedule Function of monitor.
3. Reducing the environmental temperature is effective for long life use.
When Protection board (glass, acryl) is installed over the LCD surface, enclosed into the box / wall, or stack the monitor, please utilize the temperature sensors inside monitor.
To reduce the environmental temperature, the monitor should be set Low Brightness or Cooling Fan "ON" by using Screen saver Function.
4. Please use "Screen Saver Mode" of monitor.

NOTE 2: HOW TO SETUP SCHEDULE

Using the "SCHEDULE" function allows you to set up to seven different scheduled time intervals when the LCD Monitor will be activated.

You can select the time the monitor turns on and turns off, the day of week the monitor is activated, and which input source the monitor will use for each scheduled activation period. A check mark in the box next to the number of the schedule indicates that the selected schedule is in effect.

To select which schedule to set, use the up/down arrows to move the number (1 to 7) of the schedule.

Use the (+) and (-) buttons to move the cursor horizontally within the particular schedule. Use the (▲) and (▼) buttons to increase time and select input port. The "SET" button is used to make a selection.

If you create a schedule but do not want to use a power on time, select "--" in the "ON" time slot.

If you do not want to use a power off time select "--" in the OFF time slot.

If there is no input selected ("--" showing in the input spot) the input from the previous schedule will be used.

The selection of EVERY DAY within a schedule takes priority over other schedules that are set up to operate weekly.

When schedules are overlapping, scheduled Power ON time has priority over scheduled Power OFF time.

If there are two schedules programmed for the same time, then the highest numbered schedule has priority.

When the "OFF TIMER" (see page 24) is set, the "SCHEDULE" function is disabled.

Controlling the LCD monitor via RS-232C Remote Control

This LCD monitor can be controlled by connecting a personal computer with a RS-232C terminal.

Functions that can be controlled by a personal computer are:

- Power ON or OFF
- Switching between input signals

Connection

LCD Monitor + PC

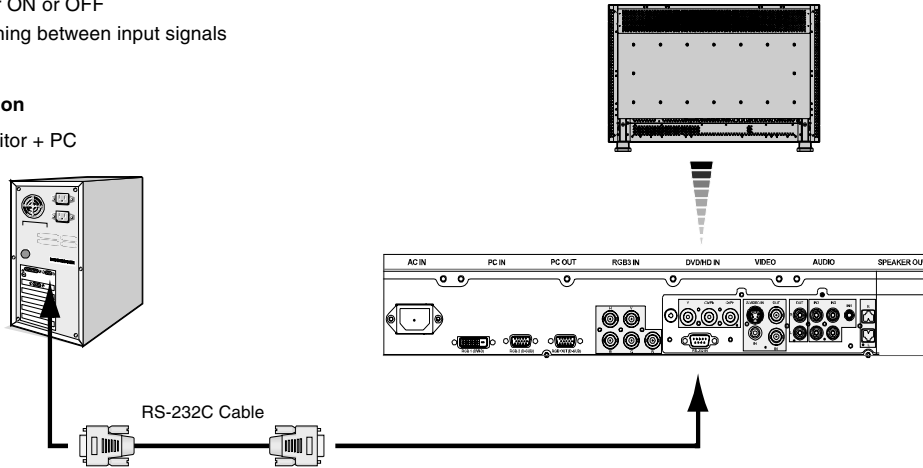

NOTE: If your PC (IBM or IBM compatible) is equipped only with a 25-pin serial port connector, a 25-pin serial port adapter is required. Contact your dealer for details.

* RS-232 OUT terminal can connect to MDT321S only. Do not connect to other equipment.

1) Interface

PROTOCOL	RS-232C
BAUD RATE	9600 [bps]
DATA LENGTH	8 [bits]
PARITY BIT	NONE
STOP BIT	1 [bits]
FLOW CONTROL	NONE

This LCD monitor uses RXD, TXD and GND lines for RS-232C control.

2) Control command diagram

The command is structured by the address code, function code, data code and end code. The length of the command is different for each function.

	Address code	Function code	Data code	End code
HEX	30h 30h	Function	Data	0Dh
ASCII	'0' '0'	Function	Data	␣

[Address code] 30h 30h (ASCII code, '0' '0'), fixed.

[Function code] A code of each fixed control move.

[Data code] A code of each fixed control data (number) and not always indicated.

[End code] 0Dh (In ASCII code, '␣') fixed.

3) Control sequence

- (1) The command from a computer to the LCD monitor will be sent in 600ms.
- (2) The LCD monitor will send a return command 600ms* after it has received and encoded. If the command isn't received correctly, the LCD monitor will not send the return command.
- (3) The personal computer checks the command and confirms if the command, which has been sent, has been executed or not.
- (4) This LCD monitor sends various codes other than return code. When having a control sequence by RS-232C, reject other codes from personal computers side.

*: The sending time of return command may delay depending on the condition (during changing of the input signal, etc.).

Example: Turn the power ON (' ' is for ASCII code)

Sending commands from the PC	Status code from LCD monitor	Meaning
30 30 21 0D '0' '0' '!' '␣'		Command for POWER ON
	30 30 21 0D '0' '0' '!' '␣'	Command received (Command echoed back)

4) Operation commands

The operation commands execute the basic operation setting of this LCD monitor.

It may not operate when changing the signal:

Operation	ASCII	HEX
POWER ON	!	21h
POWER OFF	"	22h
INPUT RGB 1	_r1	5Fh 72h 31h
INPUT RGB 2	_r2	5Fh 72h 32h
INPUT RGB 3	_r3	5Fh 72h 33h
INPUT VIDEO	_v1	5Fh 76h 31h
INPUT DVD/HD	_v2	5Fh 76h 32h
INPUT S-VIDEO*	_v3	5Fh 76h 33h

- POWER OFF command should be operated over 1 minute after the power is turned on.
- POWER ON command should be operated over 1 minute after the power is turned off.

* S-VIDEO is SEPARATE only

5) Read command

Host computer sends the command without Data-code to monitor.

After receiving this command, the monitor returns the command with Data-code of current status to host computer.

< ex. > When Host computer ask Power status of monitor, the status of monitor is powered-on.

Command from computer	Command from Monitor	Detail of command
30 30 76 50 0D 0"0"v"P[enter]		Ask about the power status of monitor.
	30 30 76 50 31 0D '0"0"v"P"1[enter]	Monitor is powered-on.

Structure of the Read-command

		ASCII		HEX	
		Function	Data (Receive)	Function	Data (Receive)
POWER	ON	vP	1	76 50	31
	OFF(stand by)	vP	0	76 50	30
Input	RGB-1(DVI-D)	vl	r1	76 49	72 31
	RGB-2(D-SUB)	vl	r2	76 49	72 32
	RGB-3(BNC)	vl	r3	76 49	72 33
	Video	vl	v1	76 49	76 31
	DVD/HD	vl	v2	76 49	76 32
	S-VIDEO	vl	v3	76 49	76 33
Picture mode	HIGHBRIGHT	vM	p1	76 4D	70 31
	STANDARD	vM	p2	76 4D	70 32
Temperature of Internal monitor	Around AV board	resolution 0.5°C	tcx1	(ex.) +25.0	74 63 78 31 2B 20 32 35 2E 30
		resolution 1°C	tc1	(ex.) +25	74 63 31 2B 20 32 35
	Around Power PCB	resolution 0.5°C	tcx2	(ex.) +30.5	74 63 78 32 2B 20 33 30 2E 35
		resolution 1°C	tc2	(ex.) +31	74 63 32 2B 20 33 31

NOTE: For complete information please see file "External_Control_MDT321S.pdf" on the CD-ROM.

Features

Reduced Footprint: Provides the ideal solution for environments requiring superior image quality but with size and weight limitations. The monitor's small footprint and low weight allow it to be moved or transported easily from one location to another.

Color Control Systems: Allows you to adjust the colors on your screen and customize the color accuracy of your monitor to a variety of standards.

sRGB Color Control: A new optimized color management standard which allows for color matching on computer displays and other peripherals. The sRGB standard, which is based on a calibrated color space, allows for optimal color representation and backward compatibility with other common color standards.

OSD (On-Screen-Display) Controls: Allow you to quickly and easily adjust all elements of your screen image via simple to use on-screen menus.

Plug and Play: The Microsoft® solution with the Windows® 95/98/Me/2000/XP operating system facilitates setup and installation by allowing the monitor to send its capabilities (such as screen size and resolutions supported) directly to your computer, automatically optimizing display performance.

Intelligent Power Manager System: Provides innovative power-saving methods that allow the monitor to shift to a lower power consumption level when on but not in use, saving two-thirds of your monitor energy costs, reducing emissions and lowering the air conditioning costs of the workplace.

Multiple Frequency Technology: Automatically adjusts monitor to the display card's scanning frequency, thus displaying the resolution required.

FullScan Capability: Allows you to use the entire screen area in most resolutions, significantly expanding image size.

VESA Standard Mounting Interface: Allows users to connect their LCD monitor to any VESA standard third party mounting arm or bracket. Allows for the monitor to be mounted on a wall or an arm using any third party compliant device. MITSUBISHI ELECTRIC recommends using mounting interface that comply with TÜV-GS and/or UL1678 standard in North America.

DVI-D: The digital-only subset of DVI ratified by the Digital Display Working Group (DDWG) for digital connections between computers and displays. As a digital-only connector, analog support is not provided off a DVI-D connector. As a DVI-based digital only connection, only a simple adapter is necessary for compatibility between DVI-D and other DVI-based digital connectors such as DFP and P&D.

TILING, Frame compensation: Demonstrates multiple screens with an accurate image and compensates for the bezel width.

ZOOM: Expands the image individually for horizontal and vertical direction.

Self-diagnosis: When an internal error should occur, a failure state will be indicated.

Troubleshooting

No picture

- The signal cable should be completely connected to the display card/computer.
- The display card should be completely seated in its slot.
- Front Power Switch and computer power switch should be in the ON position.
- Check to make sure that a supported mode has been selected on the display card or system being used. (Please consult display card or system manual to change graphics mode.)
- Check the monitor and your display card with respect to compatibility and recommended settings.
- Check the signal cable connector for bent or pushed-in pins.

Power Button does not respond

- Unplug the power cord of the monitor from the AC outlet to turn off and reset the monitor.

Image persistence

- Please be aware that LCD Technology may experience a phenomenon known as Image Persistence. Image Persistence occurs when a residual or "ghost" image of a previous image remains visible on the screen. Unlike CRT monitors, LCD monitors' image persistence is not permanent, but constant images being displayed for a long period of time should be avoided. To alleviate image persistence, turn off the monitor for as long as the previous image was displayed. For example, if an image was on the monitor for one hour and a residual image remains, the monitor should be turned off for one hour to erase the image.

NOTE: As with all personal display devices, MITSUBISHI ELECTRIC recommends displaying moving images and using a moving screen saver at regular intervals whenever the screen is idle or turning off the monitor when not in use.

Image is unstable, unfocused or swimming is apparent

- Signal cable should be completely attached to the computer.
- Use the OSD Image Adjust controls to focus and adjust display by increasing or decreasing the fine adjustment. When the display mode is changed, the OSD Image Adjust settings may need to be re-adjusted.
- Check the monitor and your display card with respect to compatibility and recommended signal timings.
- If your text is garbled, change the video mode to non-interlace and use 60Hz refresh rate.

Image of component signal is greenish

- Check to see if the DVD/HD input connector is selected.

LED on monitor is not lit (no green or red color can be seen)

- Power Switch should be in the ON position and power cord should be connected.
- Make certain the computer is not in a power-saving mode (touch the keyboard or mouse).

RED LED on monitor is blinking

- A certain failure might have occurred, please contact your nearest authorized MITSUBISHI ELECTRIC service facility.

Display image is not sized properly

- Use the OSD Image Adjust controls to increase or decrease the coarse adjustment.
- Check to make sure that a supported mode has been selected on the display card or system being used. (Please consult display card or system manual to change graphics mode.)

Selected resolution is not displayed properly

- Use OSD Display Mode to enter Information menu and confirm that the appropriate resolution has been selected. If not, select corresponding option.

No Sound

- Check to see if speaker cable is properly connected.
- Check to see if mute is activated.
- Check to see if volume is set at minimum.

Remote Control is not available

- Check the Remote Control's batteries status.
- Check if batteries are inserted correctly.
- Check if the Remote Control is pointing at the monitor's remote sensor.
- The remote control system may not function when direct sunlight or strong illumination strikes the remote control sensor of the LCD monitor, or when there is an object in the path.

"SCHEDULE"/"OFF TIMER" function is not working properly

- The "SCHEDULE" function will be disabled when the "OFF TIMER" is set.
- If the "OFF TIMER" function is enable and the power to the LCD monitor is turned off if the power supply is interrupted unexpectedly, then the "OFF TIMER" will be reset.

Either light vertical or horizontal stripes may appear, depending on the specific display pattern. This is no product fault or degradation.

Specifications

Product Specifications		Analog Input	Digital Input
LCD Module	Diagonal: Pixel Pitch: Resolution: Color: Brightness: Contrast Ratio: Response time: Viewing Angle: Design View Distance:	32" / 80.0cm 0.511mm 1366 x 768 dots Over 16 million colors (depending on video card used) 500cd/m ² (Typ.) 600:1 20ms (Tr+Tf) Up 88°/ Down 88°/ Left 88°/ Right 88° (typ) @ CR>10 875 mm/34.4 inches	
Frequency	Horizontal: Vertical:	15.625/15.734kHz, 31.5kHz - 91.1kHz 50.0/58.0 - 85.0 Hz	31.5kHz - 91.1kHz 50.0/58.0 - 85.0 Hz
Pixel Clock		25.0MHz - 162.0MHz	25.0MHz - 162.0MHz
Viewable Size		392.3 x 697.7 mm/15.4 x 27.5 inches	
Input Signal	Video: Sync: Input-terminal:	Analog RGB Video 0.7V p-p Input Impedance 75 ohm Composite sync on Green Video: 0.3Vp-p Neg. (video 0.7Vp-p Pos.) Separate HV sync: TTL level (Pos./ Neg.) Input Impedance 2.2K ohm (RGB3: 2.2k ohm/75 ohm selectable) BNC (R,G,B,H,V) 15pin Mini D-sub DVI-D (Digital)	TMDS
VIDEO Input:		Composite 1.0V p-p Input Impedance 75 ohm BNC and RCA-INPUT Y/C Y:0.7V p-p C:0.283V p-p Input Impedance 75 ohm S-TERMINAL-INPUT Component 1.0/0.7V p-p Input Impedance 75 ohm BNC-INPUT	
AUDIO Input: RS-232C:	In:	RCA PIN-JACK L/R INPUT, STEREO Mini Jack INPUT 9 Pin Mini D-sub	
Output Signal	Video: Sync: Output-terminal:	Analog RGB Video: 0.7V p-p with 75 ohm terminated Separate HV sync: TTL level (Posi / Nega) with 2.2k ohm terminated Mini D-sub 15Pin BNC 1 Output, Composite 1.0V p-p with 75 ohm terminated RCA PIN-JACK L/R: 1 Output, 0.15Vrms with 1k ohm terminated External Speaker Jack 7W + 7W	
VIDEO Output: AUDIO Output: Speaker Output:			
Resolutions Supported		640 x 480 at 60Hz to 85Hz 800 x 600 at 50Hz, 60Hz to 85Hz 1024 x 768 at 50Hz, 60Hz to 85Hz 1280 x 768 at 50Hz, 60Hz to 85Hz 1360 x 768 at 50Hz, 60Hz* to 85Hz 1280 x 1024 at 60Hz to 85Hz 1600 x 1200 at 60Hz..... Maximum Resolution * Recommended Resolution NTSC/PAL/SECAM/4.43NTSC/PAL60 Component: 480i, 480p, 720p, 1080i	
Power Supply		1.4 - 0.6A @ 100-240VAC, 50/60Hz	
Power Consumption	Power save:	Max.140W Less than 4W (Power button OFF/Main power switch ON)	
Operational Environment	Temperature: Humidity:	5 - 40°C/41 - 104°F 20 - 80% (without condensation)	
Storage Environment	Temperature: Humidity:	-20 - 60°C/-4 - 140°F 10 - 90% (without condensation)/ 90% - 3.5% x (Temp - 40°C) regarding over 40°C	
Dimension	Net: Gross:	789 (W) x 479 (H) x 140 (D) mm/31.1 (W) x 18.9 (H) x 5.5 (D) inches (without Stand) 789 (W) x 510.3 (H) x 200 (D) mm/31.1 (W) x 20.1 (H) x 7.9 (D) inches (with Stand) 944 (W) x 652 (H) x 312 (D) mm/37.2 (W) x 25.7 (H) x 12.3 (D) inches	
Weight	Net: Gross:	33.5 lbs/15.2 kg (without Stand) 36.2 lbs/16.4 kg (with Stand) 49.6 lbs/22.5 kg	
VESA compatible arm mounting interface		3 x 200mm x 200mm (8 Holes) 2 x 200 mm x 200 mm (6 Holes)	
Complied Regulatory and Guidelines		UL60950-1/CSA C22.2 No.60950-1/ TUV-GS/EN60950-1 FCC-B/DOC-B/EN55022-A/EN55024/EN61000-3-2/EN61000-3-3/CE	
Power Management		VESA DPM	
Plug & Play		VESA DDC2B, DDC/CI	
Accessories		User's manual, Power Cord x2, Video Signal Cable, Remote Control, AA Battery x 2, Clamper x 3, Screw x 4, CD-ROM, Ferrite Core x 2, Stand for the Independence x 2, Curled head Screw for stand x 2, Band x 2, Speaker plug x 1set, Main power switch cover	

NOTE: Technical specifications are subject to change without notice.

English-32

Pin Assignment

1) Analog RGB input (MiniDsub15p): R G B 2

Pin No	Name
1	Video Signal Red
2	Video Signal Green
3	Video Signal Blue
4	GND
5	DDC-GND
6	Red-GND
7	Green-GND
8	Blue-GND
9	+5V (DDC)
10	SYNC-GND
11	GND
12	DDC-SDA
13	H-SYNC
14	V-SYNC
15	DDC-SCL

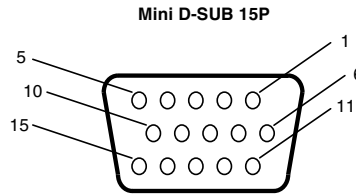

2) S-VIDEO input: V I D E O

Pin No	Name
1	GND
2	GND
3	Y (Luminance)
4	C (Chroma)

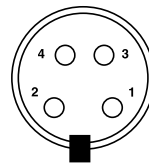

3) Digital RGB input (DVI-D): R G B 1

Pin - Assignment of DVI connector:					
1	TX2-	9	TX1-	17	TX0-
2	TX2+	10	TX1+	18	TX0+
3	Shield (TX2 / TX4)	11	Shield (TX1 / TX3)	19	Shield (TX0 / TX5)
4	NC	12	NC	20	NC
5	NC	13	NC	21	NC
6	DDC-Serial Clock	14	+5V power	22	Shield (TXC)
7	DDC-Serial Data	15	Ground	23	TXC+
8	NC	16	Hot plug detect	24	TXC-

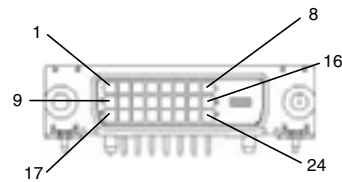

4) RS-232 input

Pin No	Name
1	NC
2	RXD
3	TXD
4	NC
5	GND
6	NC
7	RTS
8	CTS
9	NC

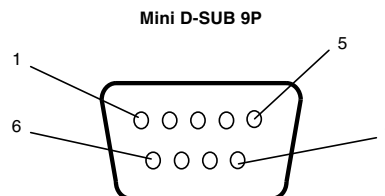

MITSUBISHI Contact Information

North America

MESCA (Mitsubishi Electric Sales Canada Inc.)
<http://www.mitsubishielectric.ca>
Information Technologies Group, 4299 14th Avenue, Markham, Ontario L3R 0J2, Canada

Sales	Phone:	+1-(905) 475-7728
	Fax:	+1-(905) 475-7958
	E-mail:	projectors@mitsubishielectric.ca
Technical	Phone:	+1-(905) 475-7728
	Fax:	+1-(905) 475-7958

Customer Care
E-mail: support@mitsubishielectric.ca

MDEA (Mitsubishi Digital Electronics America, Inc.)
(Warranty Registration)
<http://www.mitsubishi-presentations.com/>
Presentation Products Division, 9351 Jeronimo Road, Irvine, CA 92618 U.S.A.

Phone	Main Line:	+1-(949) 465-6000
	Technical:	+1-(888) 307-0309
	Product Information:	+1-(888) 307-0312

Technical Support
E-mail: tsupport@mdea.com

Europe

MEU-FRA (Mitsubishi Electric Europe B.V. French Branch)
25, Boulevard des Bouvets 92 741, Nanterre CEDEX, France

Sales	Phone:	+33 (0)1 55-68-55-07
	Fax:	+33 (0)1 55-68-57-31
Technical	Phone:	+33 (0)1 55-68-56-42
	Fax:	+33 (0)1 55-68-57-31

MEU-GER (Mitsubishi Electric Europe B.V. German Branch)
<http://www.mitsubishi-evs.de/>
Gothaer Strasse 8, 40880 Ratingen, Germany

MEU-IRL (Mitsubishi Electric Europe B.V. Irish Branch)
<http://www.mitsubishi.ie/>
Westgate Business Park, Ballymount, Dublin 24, Ireland

Sales	Phone:	+353-(0)1- 4198844
	Fax:	+353-(0)1-4564422
Technical	Phone:	+353-(0)1-4198807
	Fax:	+353-(0)1-4198895

MEU-IT (Mitsubishi Electric Europe B.V. Italian Branch)
Centro Direzionale Colleoni, Palazzo Persero-Ingresso 2, Via Paracelso 12, 20041 Agrate Brianza, Italy

Sales	Phone:	+39-(0)39-60531
	Fax:	+39-(0)39-6053214
	E-mail:	info.projector@it.mee.com

MEU-NL (Mitsubishi Electric Europe B.V. Benelux Branch)
<http://www.MitsubishiElectric.nl>
Nijverheidsweg 23a, 3641 RP Mijdrecht, The Netherlands

Sales	Phone:	+31-297-282461
	Fax:	+31-297-283936
	E-mail:	info@mitsubishi.nl
Technical	Phone:	+31-297-282461
	Fax:	+31-297-283936
	E-mail:	info@mitsubishi.nl

MEU (MITSUBISHI ELECTRIC EUROPE B.V.)
<http://www.mitsubishi-projector.ru/>
Moscow Representative Office, 12/1 Gonchamaya St. 109240, Moscow, Russia

Sales	Phone:	+7 (095) 915 8602
	Fax:	+7 (095) 915 8603

MEU-SP (Mitsubishi Electric Europe B.V. Spanish Branch)
<http://www.mitsubishielectric.es/>
Ctra. de Rubi, 76-80, 08190 Sant Cugat del Valles, Barcelona, Spain

Sales	Phone:	+34-93.565.31.54
	Fax:	+34-93.589.43.88
	E-mail:	mitsubishi.profesional@sp.mee.com
Technical	Phone:	+34-93.586.27.51
	Fax:	+34-93.699.74.45
	E-mail:	mitsubishi.profesional@sp.mee.com

MEU-SWE (Mitsubishi Electric Europe B.V. Scandinavian Branch)
Hammarbacken 14, Box 750, S-19127, Sollentuna, Sweden

Sales	Phone:	+46-(0)8-6251070
	Fax:	+46-(0)8-6251036
Technical	Phone:	+46-(0)8-6251052
	Fax:	+46-(0)8-6251036

MEU-UK (Mitsubishi Electric Europe)
<http://www.mitsubishi.co.uk/evs/>
Visual Information Systems Division, Travellers Lane, Hatfield, Hertfordshire, AL10 8XB

Sales	Phone:	+44 (1707) 278684
	Fax:	+44 (1707) 278541
	E-mail:	projector.info@meuk.mee.com
Technical	Phone:	+44 (870) 606 5008
	Fax:	+44 (1506) 431927
	E-mail:	projector.info@meuk.mee.com

Russia (Mitsubishi Electric Europe B.V. Moscow Representative Office)
52, bldg.5, Kosmodamianskaya Nab, 113054, Moscow, Russian Federation

Sales	Phone:	+7 (095) 721 2070
	Fax:	+7 (095) 721 2071
Technical	Phone:	+7 (095) 721 2070
	Fax:	+7 (095) 721 2071



Part No.1E504541
Printed in China